









Assembly Manual

| | | | | | | | | |
|---|---|-------|---|---|-------|---|---|-----|
| A |  | 1PC | B |  | 1PC | C |  | 1PC |
| D |  | 2PCS | E |  | 4PCS | F |  | 1PC |
| G |  | 12PCS | H |  | 12PCS | | | |

Step 1: Lay Part A with holes facing up on flat surface

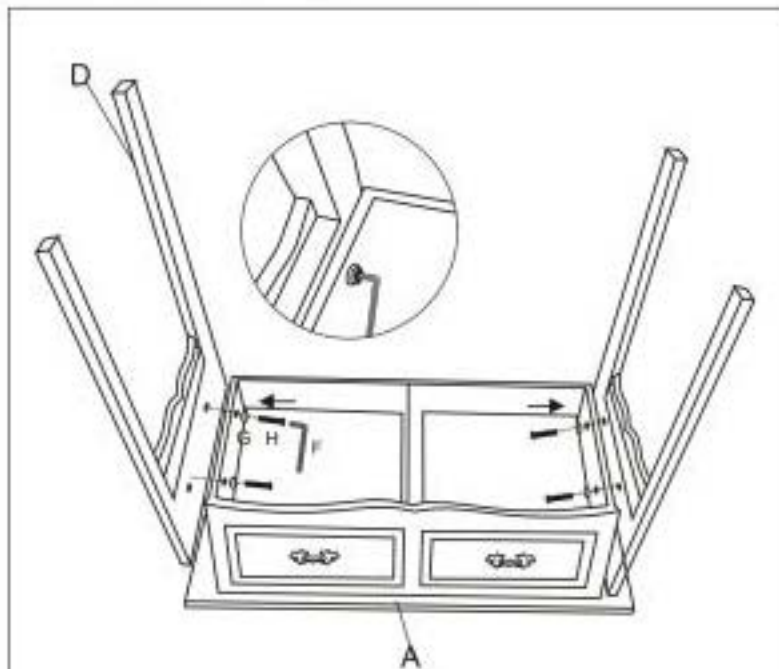

Step 2: Parts D screw to Part A using Part F, Parts G and Parts H



Step 3: Lay Part B with holes facing up on flat surface

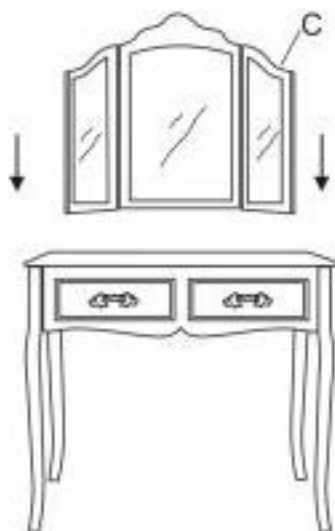

Step 4: Parts E screw to Part B using Part F, Parts G and Parts H



Step 5: Put Part C on the top of Part A