

MIRROR ASSEMBLY

RTG 32233671

- 1) PLACE THE MIRROR PERFECTLY IN THE MIDDLE OF THE DRESSER
- 2) SWING THE METAL SUPPORTS IN VERTICAL POSITION AND FIX THEM TO THE MIRROR USING THE 8 SCREWS TSP 4x12 mm INTO THE METAL INSERTS, AS SHOWN BELOW

- 1) COLOCAR EL ESPEJO EXACTAMENTE EN EL CENTRO DEL TOCADOR
- 2) MOVER EL SOPORTE DE METAL A POSICION VERTICAL Y AJUSTARLO AL ESPEJO USANDO LOS 8 TORNILLOS TSP 4x12 mm, INSERTANDOLOS EN EL METAL COMO SE MUESTRA ABAJO

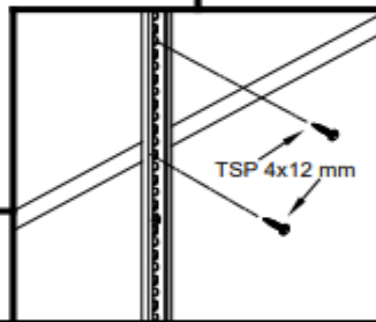

N° 8 SCREWS
TSP 4x12 mm

N° 8 TORNILLOS
TSP 4x12 mm



- ORNATA -

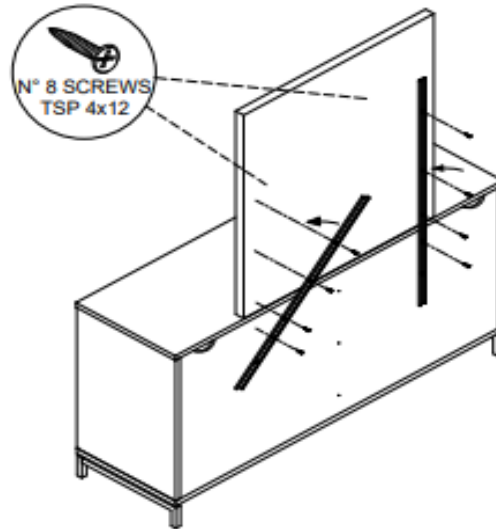

- CADENZA -

