



Manufactured for Rooms to Go.

Assembly Instructions For



NAJA BDPOSIMR 32259358 5935-2 MIRROR GRAY



NAJA BDPOSIMRW 32259372 5937-2 MIRROR BROWN

Thank you for purchasing this quality product. Be sure to check all packing materials carefully for small parts, which may have come loose inside the carton during shipment. Identify and count all parts and compare with the **HARDWARE LIST** below.

Caution: Please read instructions thoroughly before unpacking assembly parts.

1. We recommend that you assemble this product with the assistance of another person; this will make assembly easier, and will help to eliminate damage to the product or injury to persons during assembly.
2. Please do not over tighten screws or bolts until the assembly is completed.
3. Please put all parts on a non-abrasive floor before assembly, and follow the assembly steps to assemble your newly purchased product correctly and efficiently.

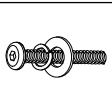
NO.	Parts List		Q' TY
A		Mirror	1
B		Support post	2
C		Dresser	1

NO.	Hardware List		Q' TY
1		Ø1/4" x 20 x 1-1/2"L Allen Bolt	8
		Ø1/4" x 1.5mm Spring washer	8
		Ø1/4" x Ø22 x 1.5mm Flat washer	8
		Allen wrench 4 x 74 x 30mm	1

STEP 1

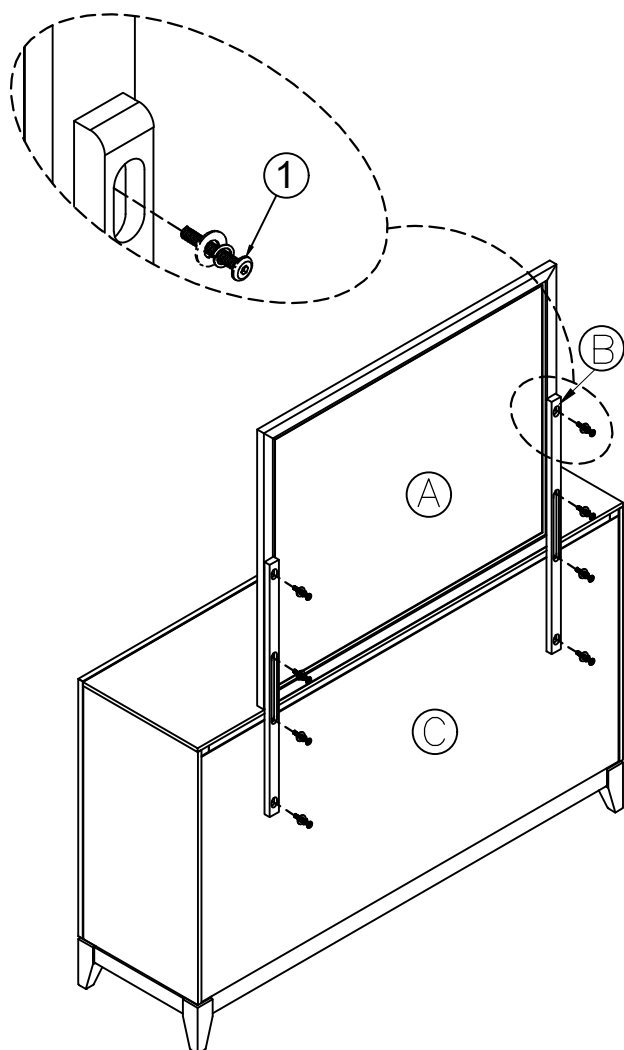

COMPLETE

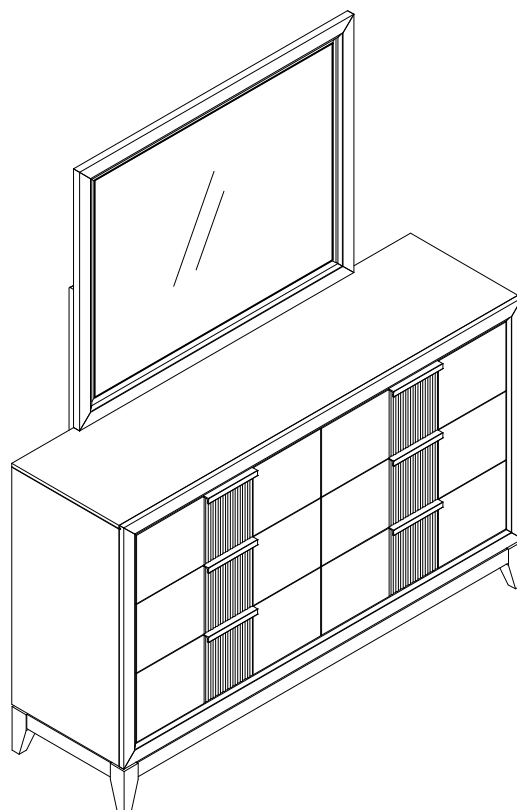

Assembly completed
MADE IN VIET NAM