

FIBI

Model	BEATRICE		
Item	MIRROR ASSEMBLING		
Code	7222	SKU#	32272229
Date	22/02/2024	Rev.	1

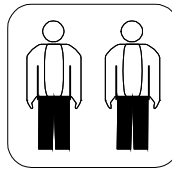

Hardware :

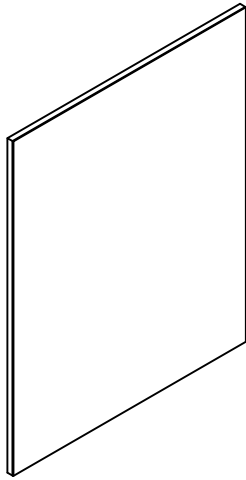
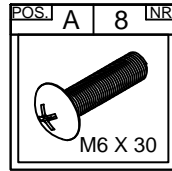

1

The mirror supports are already attached to the mirror.

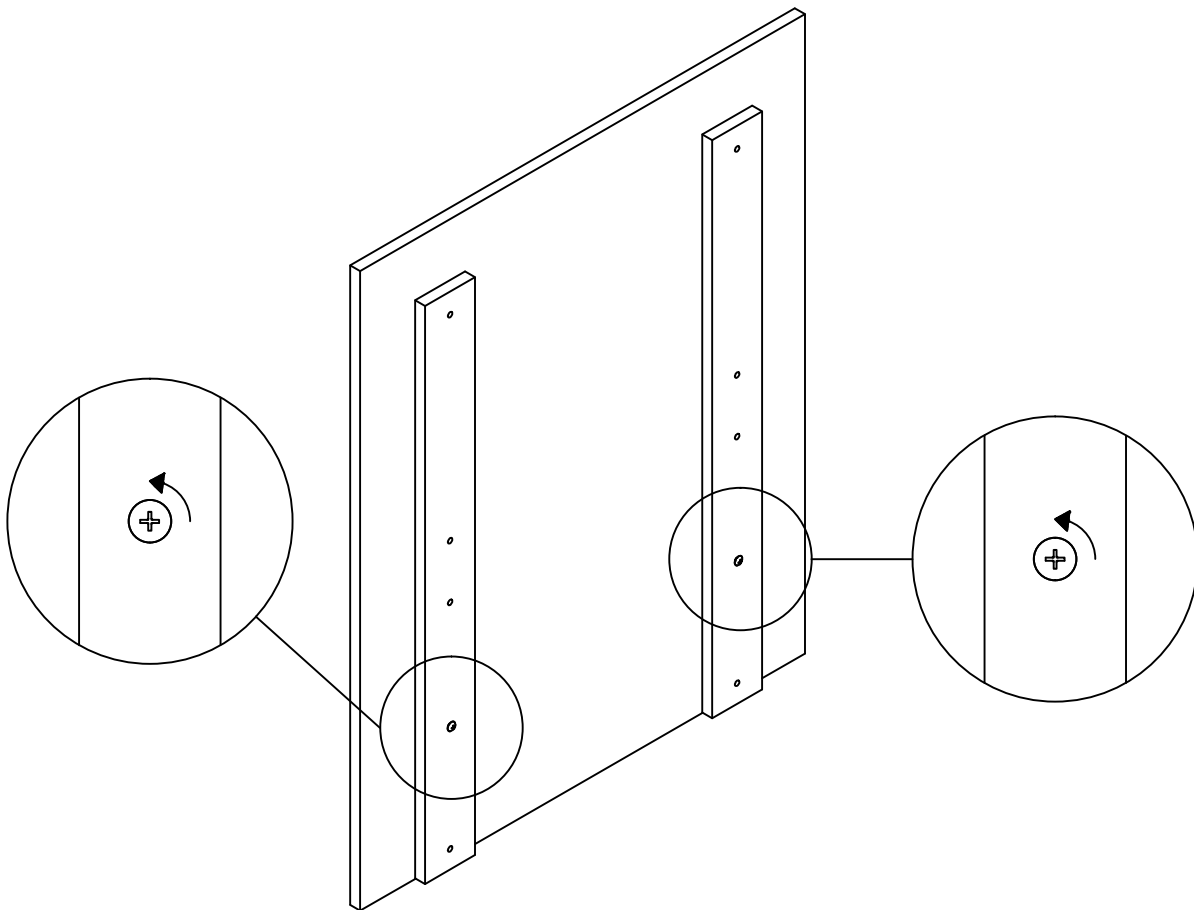

During the assembly process, use carton as a base to avoid scratches.

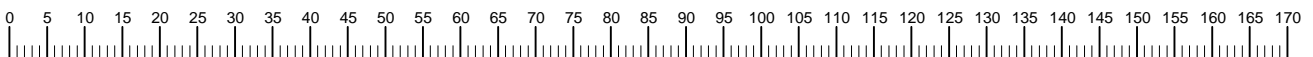

- 2** Loosen the screws so that the supports can be moved into extension mode to be attached to the dresser.

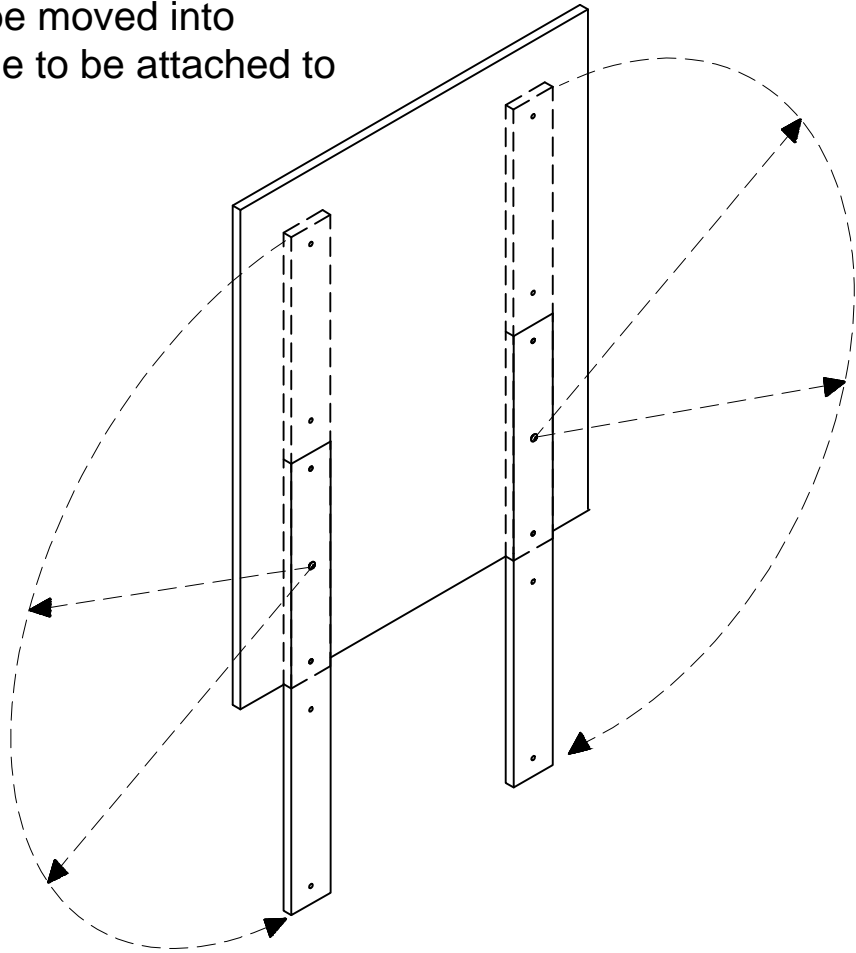

- 3** Insert the screws into the second hole to secure the supports into the top section of the mirror.

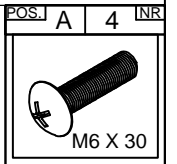
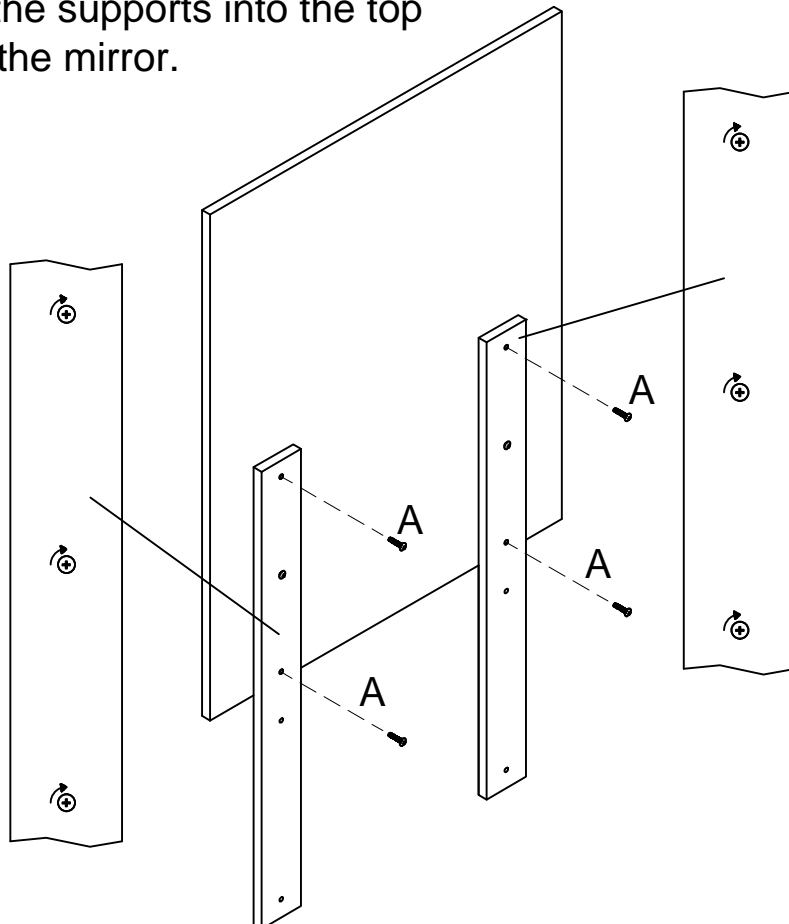

4

Carrefully place the mirror on top of the dresser and insert the screws into the dresser. Ensure that all screws are tight and mirror is secure.

