

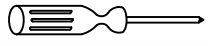





# Assembly Instructions

NAJA 9050-2 MIRROR  
NAJA 9050-1 DRESSER

SKU # 32290506  
SKU # 32190504

Thank you for purchasing this quality product. Be sure to check all packing material carefully for small parts, which may have come loose inside the carton during shipment. Identify and count all parts and compare with the **HARDWARE LIST** below.

PARTS LIST	NO.	Description	Q' TY	TOOLS REQUIRED ( NOT PROVIDED)	
	A	Dresser (Sold Separately)	1	Description	Sketch
	B	Mirror	1	Philips screwdriver	
	C	Support Slats	2		

HARDWARE LIST	NO.	Description	Q' TY	
	1	Allen Bolt $\phi 5/16'' \times 18 \times 50\text{mm}$		8
		Spring washer $\phi 5/16'' \times \phi 13\text{mm} \times 1.5\text{mm}$		8
		Flat washer $\phi 5/16'' \times \phi 19\text{mm} \times 1.5\text{mm}$		8
	2	Allen wrench (4mm)		1
3	Anti tipping kits		1 Set	

**Remark:**  
Tipping hardware attached to the back panel.

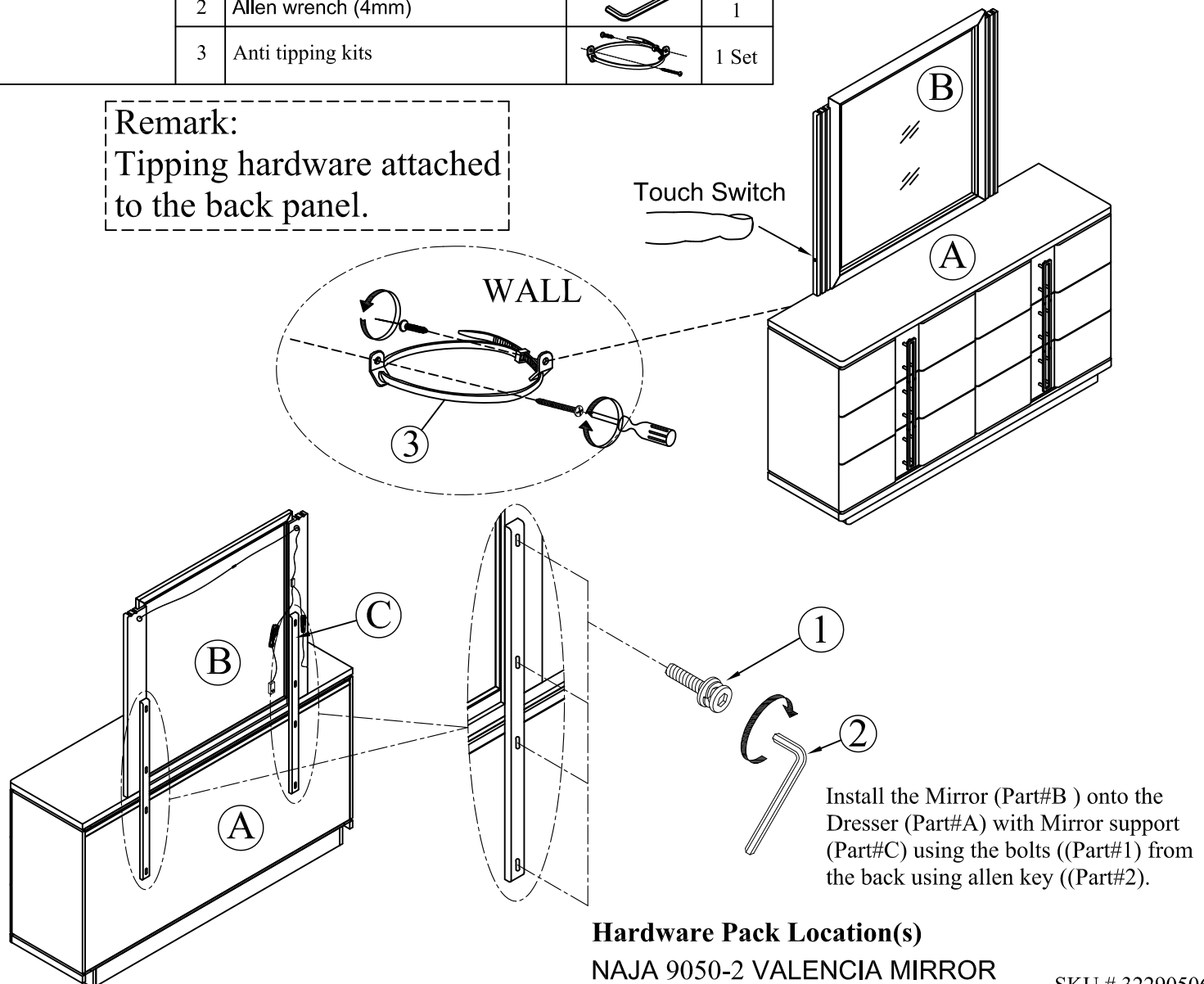

Install the Mirror (Part#B ) onto the Dresser (Part#A ) with Mirror support (Part#C) using the bolts ((Part#1) from the back using allen key ((Part#2).

**Hardware Pack Location(s)**  
NAJA 9050-2 VALENCIA MIRROR SKU # 32290506  
NAJA 9050-1 VALENCIA DRESSER SKU # 32190504