

Assembly instructions for









RIEE: 32323331 / 32323343 / 32423333 / 32423345
 32723339 / 32723341 / 32823331 / 32823343
 32923333 / 32923345









QN & KG Headboard 333/334-140/143
QN & KG Footboard 333/334-141/144
QN & KG Rails 333/334-142

Caution: Please read instructions thoroughly before unpacking assembly parts. Sharp, exposed staple tips can cause injury, therefore, for your protection, please remove any exposed staples used in packing.

1. We recommend that you should assemble this product with the assistance of another person; this will make assembly easier, and will help to eliminate damage to the product or injury to persons during assembly.
2. Be sure to check all packing materials carefully for small parts that may have come loose inside the carton during shipment.
3. Please do not over tighten screws or bolts.
4. Please put all parts on a non-abrasive floor before assembly, and follow the assembly steps to assemble your newly purchased product correctly and efficiently.

- Do not allow children to climb on furniture.
- Do not place television sets on top of chests, door chests and/or dressers.
- Please place heaviest objects in the lowest drawers.
- Please have no more than one drawer open at a time.

NO.	HARDWARE LIST (333/334 -140/143)		Q'TY
1		(L57x4MM) ALLEN KEY	1 piece
2		(Ø1/4 * 13 * 1-1/2"L) BOLT	2 pieces
3		(Ø1/4*13*1.2MM) SPRING WASHER	2 pieces
4		(Ø1/4*19*1.8MM) FLAT WASHER	2 pieces
5		(Ø 5/16 * 13 * 2"L) BOLT	6 pieces
6		(Ø5/16*13*1.2MM) SPRING WASHER	6 pieces
7		(Ø5/16*19*1.8MM) FLAT WASHER	6 pieces
HARDWARE LIST (333/334-141/144)			
8		8*30MM SCREW	10 pieces

NO.	PARTS LIST (333/334-140/143)		
A		Headboard	1 piece
B		Headboard legs (L+R)	2 pieces
C		Footboard	1 piece
D		Bun feet	2 pieces
E		Headboard Bottom Stretcher	1 piece
F		Side rail	2 pieces
G		Bed Slat	5 pieces
H		Long Slat Support Leg	10 pieces
I		Short Slat Support Leg	10 pieces

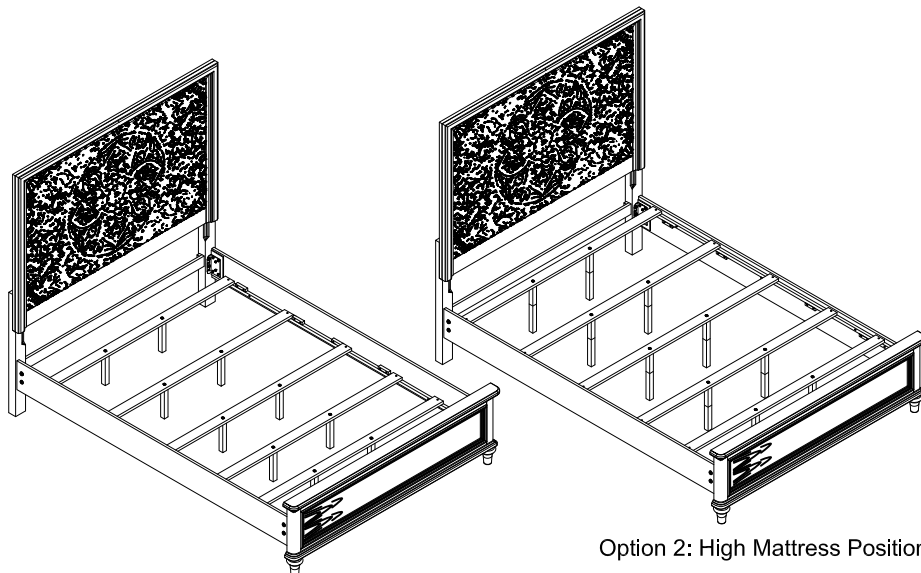
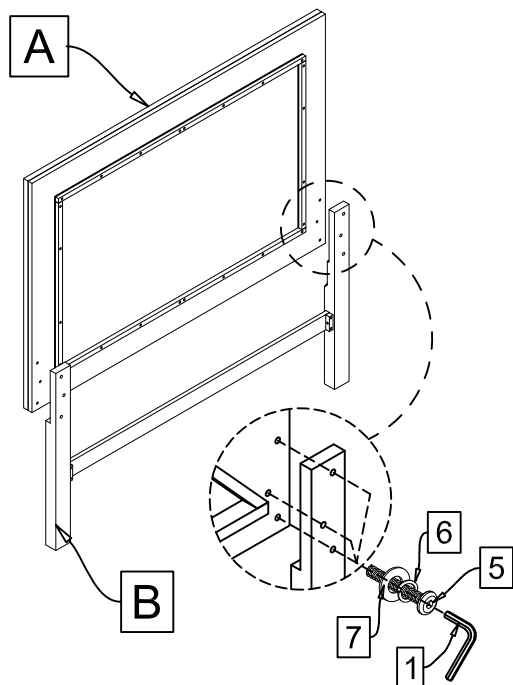

Option 1: Low Mattress Position

Option 2: High Mattress Position

Assembly completed

Assembly instructions for

RIEE: 32323331 / 32323343 / 32423333 / 32423345
 32723339 / 32723341 / 32823331 / 32823343
 32923333 / 32923345

QN & KG Headboard
QN & KG Footboard
QN & KG Rails

333/334-140/143
333/334-141/144
333/334-142

The reversible siderails can be set up 2 options for mattress position.

Option 1: The cleats support slat are at low position so that the mattress is at low position.

You will need just the long slat support for this option.

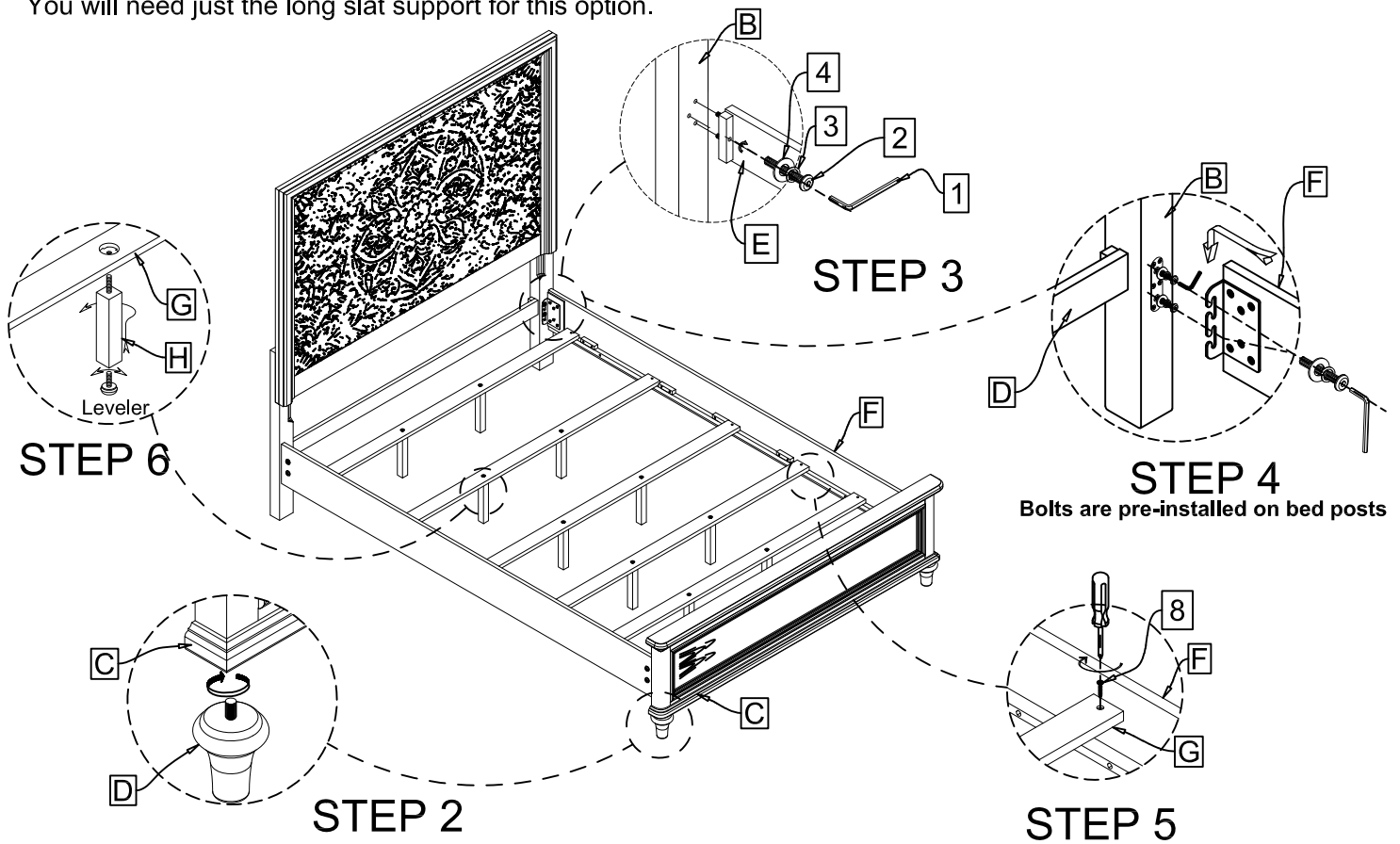

Option 2: The cleats support slat are high position so that the mattress is at high position. You will need both long & short slat support for this option. The long & short support are connected together before connect to the bed slats.

