

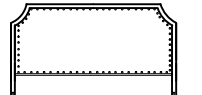

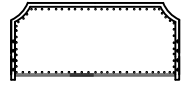
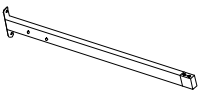
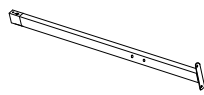
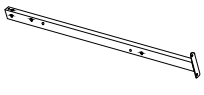
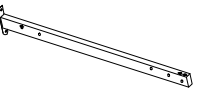

PARTS AND HARDWARE / PIÈCES ET QUINCAILLERIE / PIEZAS Y HERRAMIENTAS

 x1 Headboard panel x1 Tête de lit x1 Panel de cabecera	 x1 Footboard x1 Pied de lit x1 Pie de cama	 x1 Side Rail x1 Traverse x1 Travesaño lateral	 x1 Side Rail x1 Traverse x1 Travesaño lateral	 x1 Side Rail x1 Traverse x1 Travesaño lateral	 x1 Side Rail x1 Traverse x1 Travesaño lateral	 x2 Slats x2 Lattes x2 Listónes	 x1 Slat x1 Latte x1 Listón	 x2 Legs extension x2 Rallonges de patte x2 Extensiones de patas
 x12 Center legs x12 Pattes centrales x12 Patas centrales	 x4 Adjustable levelers x4 Patin réglables x4 Niveladors ajustable	 x1 Allen Key x1 Clé hexagonale x1 Llave Allen	 x34 Small Bolts 1/4" x34 Petit boulons 1/4" x34 Prequeño pernos 1/4"	 x8 Large Bolts 1/4" x8 Gros boulons 1/4" x8 Perno grandes 1/4"	 x4 Feet x4 Pieds x4 Pies			
 X8 Flat Washers X8 Rondelle plates X8 Arandela planas	 X8 Nuts X8 Écrous X8 Tuercas	 X1 Open wrench X1 Clé à fourche X1 Llave de boca	 X4 Brackets X4 Supports X4 Soportes					

When placing furniture on non-carpeted flooring, HMI recommends the use of floor protection such as an area rug or furniture pads. Area rugs and padding not included with purchase.
 Avant de déposer le meuble sur un revêtement de sol rigide, HMI recommande de protéger le plancher en utilisant une carpepe ou des patins, par exemple. Carpepe et patins non compris.
 Antes de colocar el mueble en un suelo sin alfombra, HMI recomienda protegerlo con un tapete o almohadillas, por ejemplo. Tapete y almohadillas no incluidos.

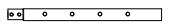
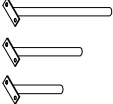
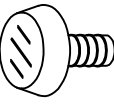
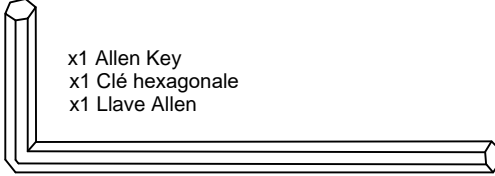
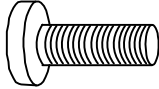
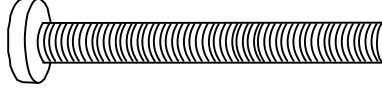
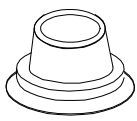
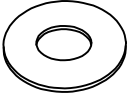
ASSEMBLY INSTRUCTIONS / INSTRUCTIONS D'ASSEMBLAGE / INSTRUCCIONES PARA EL ENSAMBLAJE

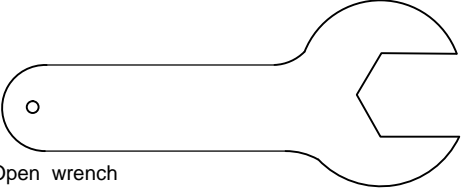
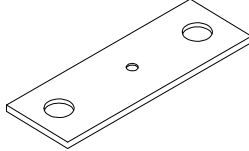
Step 1.

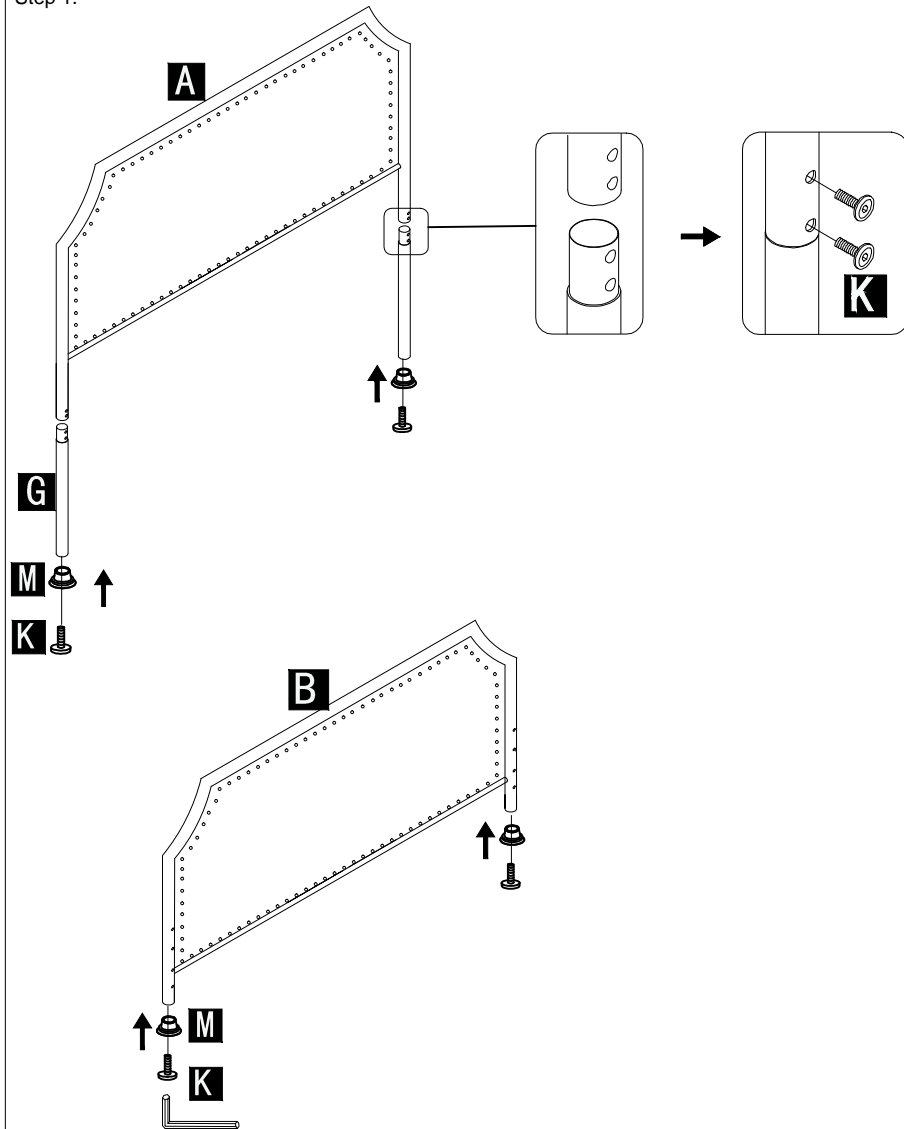

Step 2.

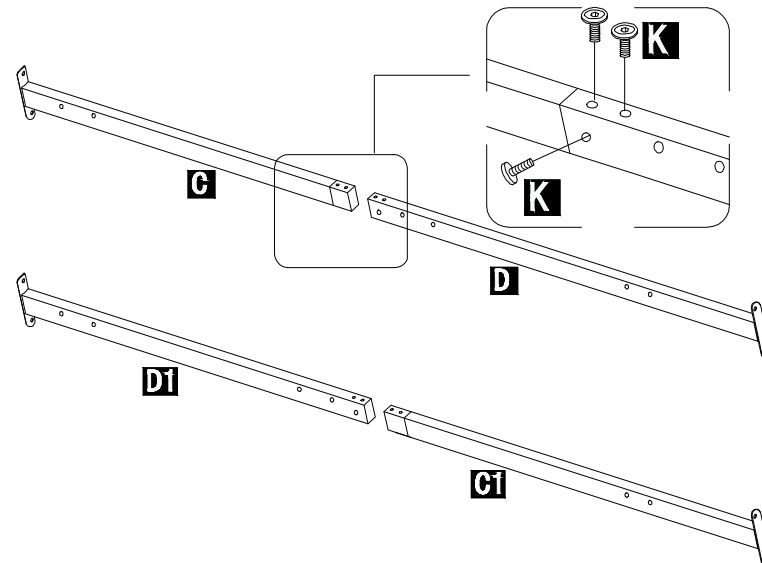

ASSEMBLY INSTRUCTIONS / INSTRUCTIONS D'ASSEMBLAGE / INSTRUCCIONES PARA EL ENSAMBLAJE

Step 3.

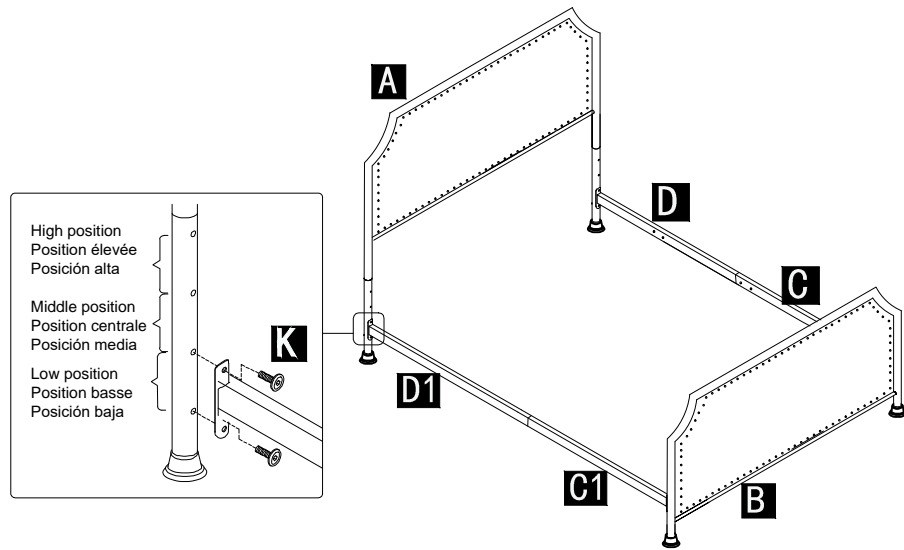

Step 4.

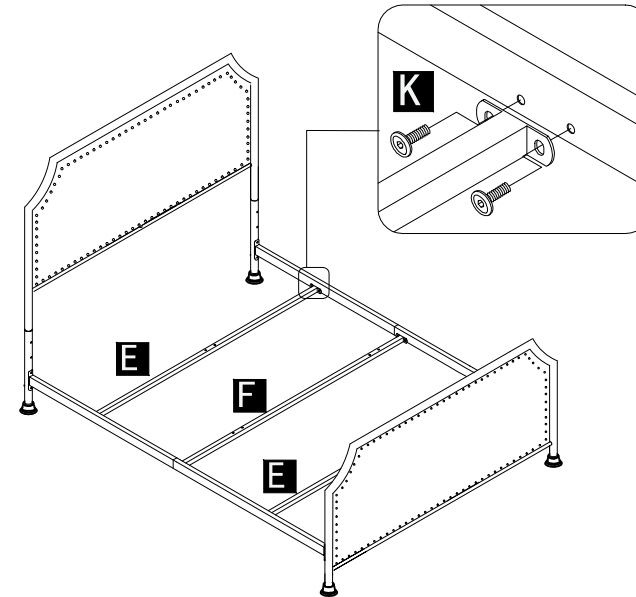

Step 5.

