





ASSEMBLY INSTRUCTION



DVDR HD4221-404 NIGHTSTAND

Manufactured by (DVDR) for ROOMSTOGO

SKU# 32542210

Thank you for purchasing this quality product. Be sure to check all packing material carefully for small parts, which may have come loose inside the carton during shipment. Identify and count all parts and compare with the parts list below:

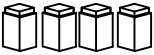
Hardware List	No.	Picture	Description	Dimension	Qty
	①	 JCBC nylock with Spring Washer and Washer	JCBC SCREW NYLOCK	M6 x P1.0 x 60mm	8 Pcs
			SPRING WASHER	M6 x 12mm	
			FLAT WASHER	M6 x 19 x 1.0mm	
②	 Allen Key (M4)		4 x 65mm	1 Pc	
③	 Phillips Screwdriver		-	Not Provided	

Part List	No.	Picture	Description	Qty
	A	 Nightstand		1 Pc
	B	 Leg (Packed Inside Drawer)		4 Pcs
	C	 Tipping Restraint (Packed Inside Drawer)		1 Pc

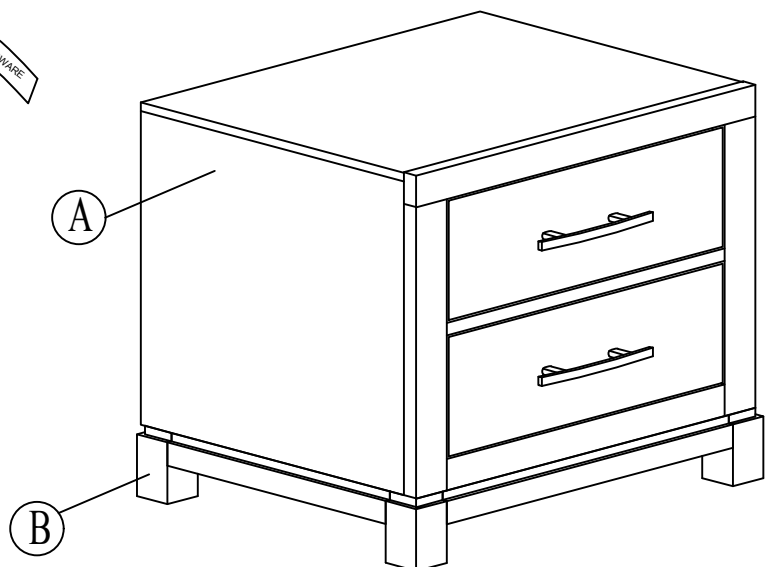
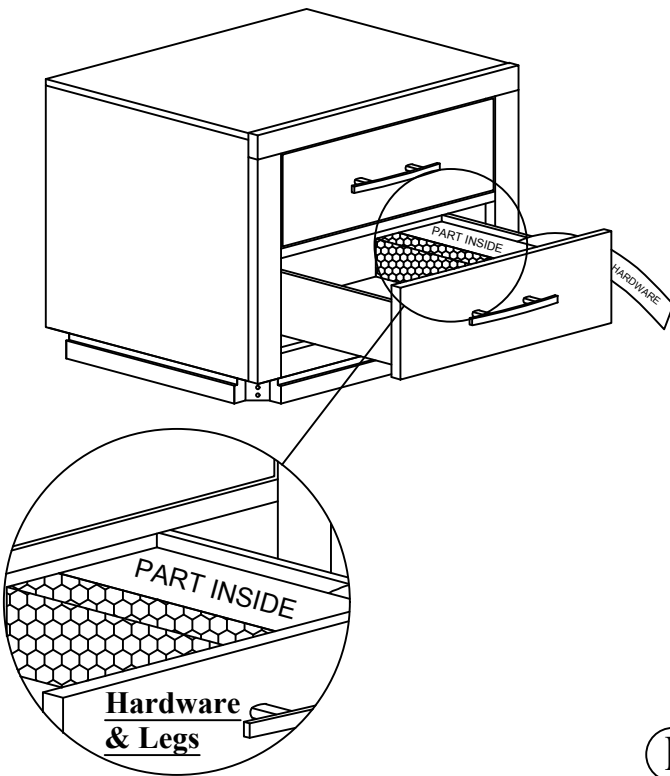

Hardware Pack Location (s) : Bolts pack inside bottom drawer (Leg inner carton)

Nightstand SKU # 32542210

Version #1-2024/04/08

PAGE 1 OF 2



ASSEMBLY INSTRUCTION

DVDR HD4221-404 NIGHTSTAND

Manufactured by (DVDR) for ROOMSTOGO

SKU# 32542210

ASSEMBLY TIPS:

1. Remove hardware from box and sort by size.
2. Please check to see that all hardware and parts are present prior start of assembly.
3. Please follow attached instructions in the same sequence as numbered to assure fast and easy assembly.

▲ WARNING!

1. Don't attempt to repair or modify parts that are broken or defective. Please contact the store immediately.
2. This product is for home use only and not intended for commercial establishments.

Assembly Step

STEP 1

Fasten the leg as shown.

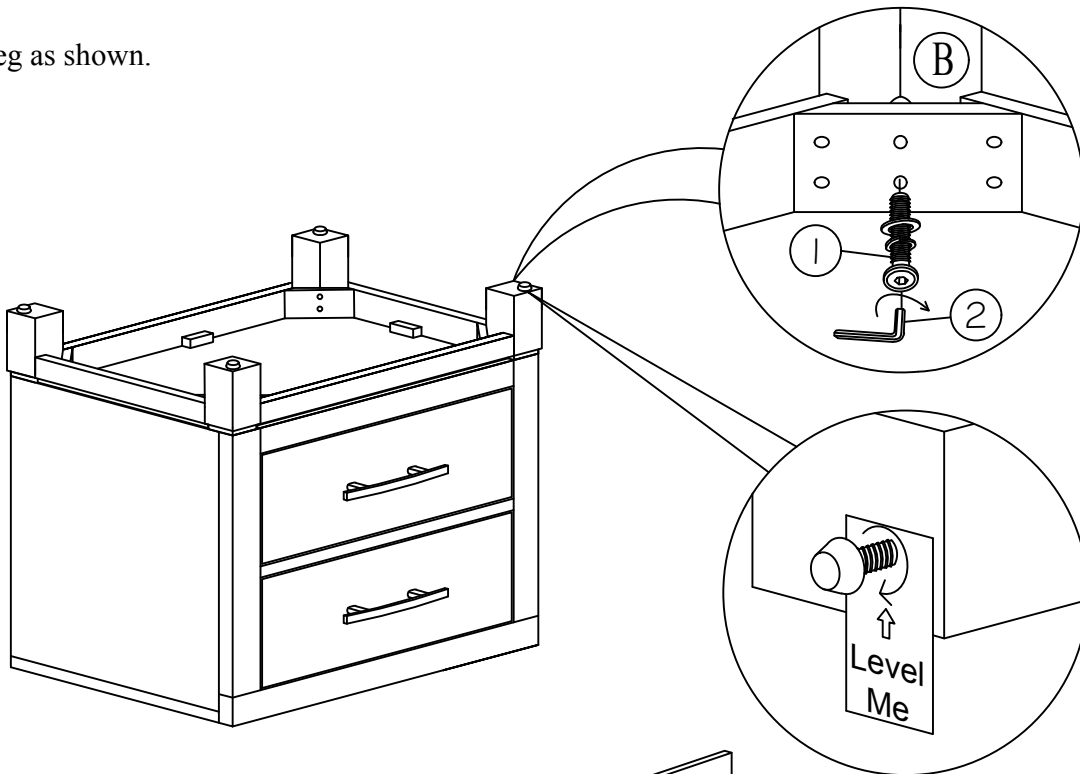

STEP 2

Affix Tipping Restraint to wall behind Nightstand

