



INSTRUCTIONS D'ASSEMBLAGE
ASSEMBLY INSTRUCTIONS

MONARCH
SPECIALTIES INC.

I 5968T

LIT -
SIMPLE / BORDURE EN ARGENT VELOUR GRIS
FONCE

BED -
TWIN SIZE / DARK GREY VELVET WITH CHROME
TRIM



POUR DE L'ASSISTANCE OU POUR COMMANDER
DES PIÈCES CONTACTEZ NOTRE DÉPARTEMENT
DE SERVICE À LA CLIENTÈLE.

FOR ASSISTANCE OR TO ORDER PARTS
CONTACT OUR CUSTOMER SERVICE DEPARTMENT

WWW.MONARCHSERVICE.COM

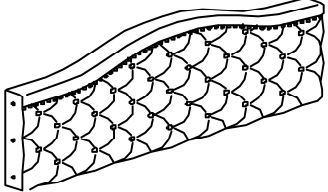
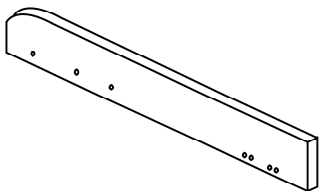
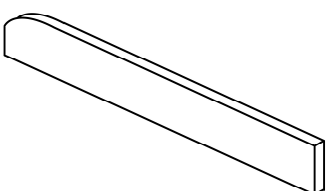
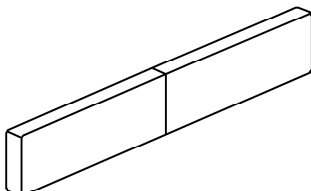
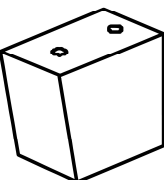

LISTE DES PIÈCES
PARTS LIST

PIÈCE / PART #	IMAGE	DESCRIPTION	QTY / QTÉ
1		HEADBOARD TÊTE DE LIT	1
2		FRONT FACING HEADBOARD RIGHT LEG TÊTE DE LIT AVANT DROITE	1
3		FRONT FACING HEADBOARD LEFT LEG TÊTE DE LIT AVANT GAUCHE	1
4		FOOTBOARD PIED DE LIT	1
5		FRONT FACING FOOTBOARD RIGHT LEG PIED DE LIT AVANT DROIT	1

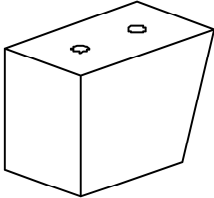
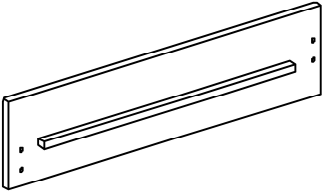
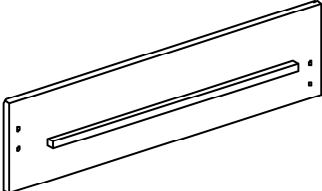
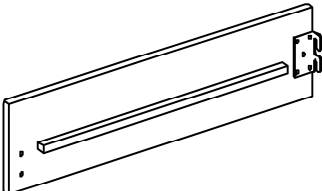
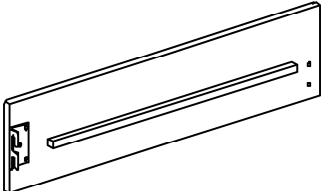

LISTE DES PIÈCES
PARTS LIST

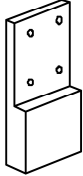
PIÈCE / PART #	IMAGE	DESCRIPTION	QTY / QTÉ
6		<p>FRONT FACING FOOTBOARD LEFT LEG PIED DE LIT AVANT GAUCHE</p>	1
7		<p>FRONT FACING LEFT SIDE RAIL RAIL DE CÔTÉ GAUCHE</p>	1
8		<p>FRONT FACING RIGHT SIDE RAIL RAIL DE CÔTÉ DROIT</p>	1
9		<p>FRONT FACING LEFT SIDE RAIL RAIL DE CÔTÉ GAUCHE</p>	1
10		<p>FRONT FACING RIGHT SIDE RAIL RAIL DE CÔTÉ DROIT</p>	1

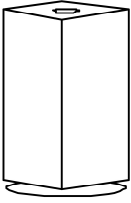
LISTE DES PIÈCES
PARTS LIST

PIÈCE / PART #	IMAGE	DESCRIPTION	QTY / QTÉ
11		<p align="center">SIDE RAIL SUPPORT LEG RAIL DE CÔTÉ PATTE DE SOUTIEN</p>	2
12		<p align="center">SLAT LAMELLE</p>	4
13		<p align="center">SUPPORT LEG PATTE DE SOUTIEN</p>	4

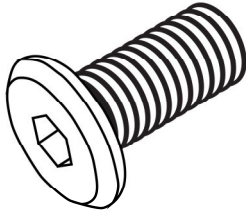
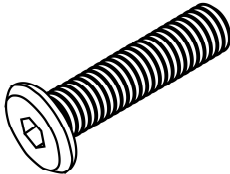
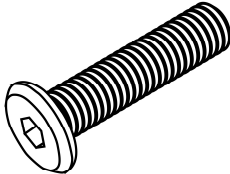
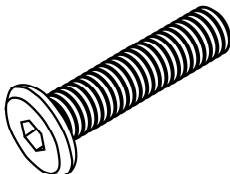
LISTE DES PIÈCES DE MONTAGE
HARDWARE LIST

PIÈCE / PART #	IMAGE	DESCRIPTION	QTY / QTÉ
A		ASSEMBLING BOLT - Ø 5/16" X 3/4" BOULON D'ASSEMBLAGE - Ø 5/16" X 3/4"	4
B		ASSEMBLING BOLT - Ø 1/4" X 1" BOULON D'ASSEMBLAGE - Ø 1/4" X 1"	8
C		ASSEMBLING BOLT - Ø 1/4" X 1 3/8" BOULON D'ASSEMBLAGE - Ø 1/4" X 1 3/8"	10
D		ASSEMBLING BOLT - Ø 5/16" X 2" BOULON D'ASSEMBLAGE - Ø 5/16" X 2"	4
E		ASSEMBLING BOLT - Ø 1/4" X 2 3/4" BOULON D'ASSEMBLAGE - Ø 1/4" X 2 3/4"	2

LISTE DES PIÈCES DE MONTAGE
HARDWARE LIST

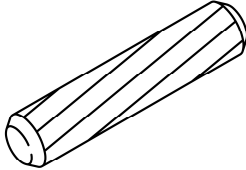
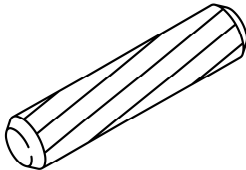
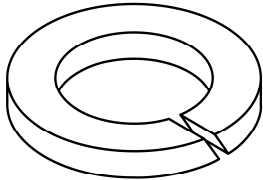
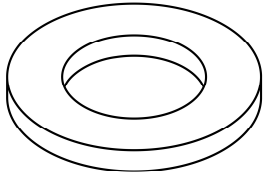
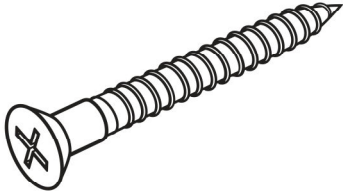
PIÈCE / PART #	IMAGE	DESCRIPTION	QTY / QTÉ
F		WOODE DOWEL Ø 5/16" X 1 3/16"	2
G		WOODE DOWEL Ø 3/8" X 1 3/16"	4
H		LOCK WASHER - M6 ENTRETOISE DE MÉTAL - M6	14
I		METAL WASHER - M6 RONDELLE DE MÉTAL - M6	14
J		ASSEMBLING SCREW - Ø 1/8" X 1 1/4" VIS D'ASSEMBLAGE - Ø 1/8" X 1 1/4"	8

LISTE DES PIÈCES DE MONTAGE
HARDWARE LIST

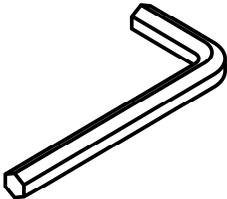
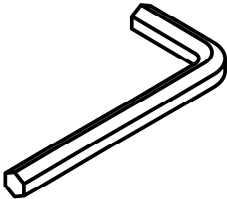
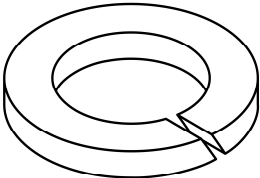
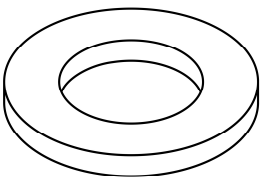
PIÈCE / PART #	IMAGE	DESCRIPTION	QTY / QTÉ
K		<p align="center">HEX KEY - M5 X 2 9/16"</p> <p align="center">CLÉ HEXAGONALE - M5 X 2 9/16"</p>	1
L		<p align="center">HEX KEY - M4 X 2 9/16"</p> <p align="center">CLÉ HEXAGONALE - M4 X 2 9/16"</p>	1
M		<p align="center">LOCK WASHER - M8</p> <p align="center">ENTRETOISE DE MÉTAL - M8</p>	4
N		<p align="center">METAL WASHER - M8</p> <p align="center">RONDELLE DE MÉTAL - M8</p>	4



OUTIL DE VÉRIFICATION DE DIMENSIONS DES PIÈCES
HARDWARE DIMENSIONS VERIFICATION TOOL



ÉTAPE / STEP 3

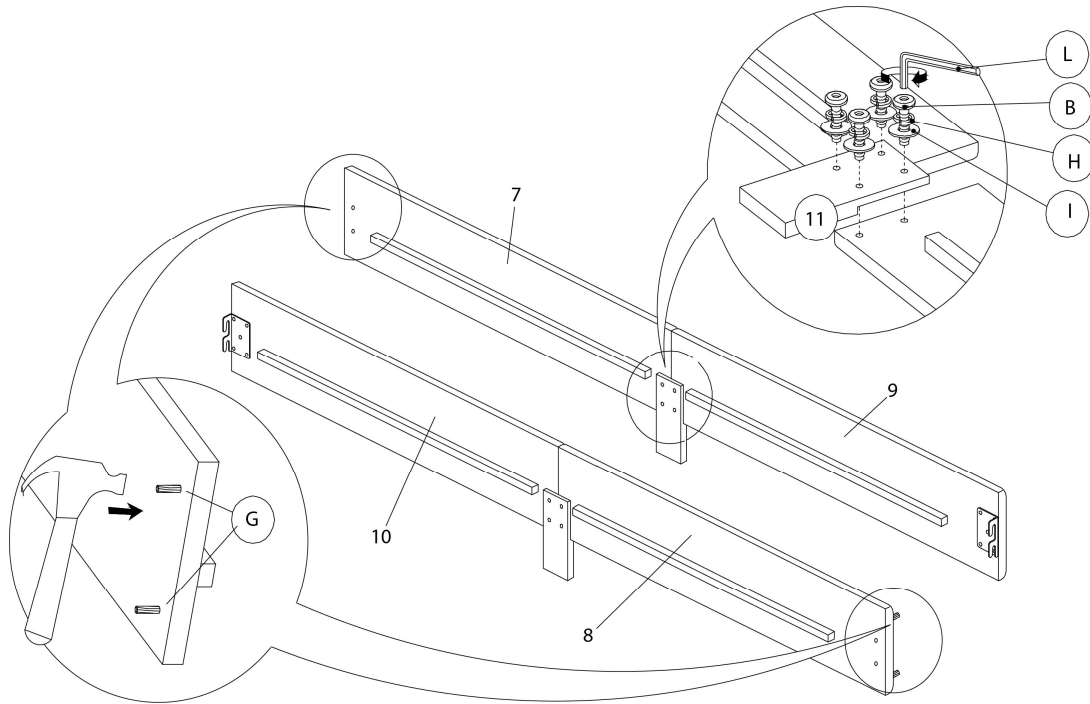

ÉTAPE / STEP 4

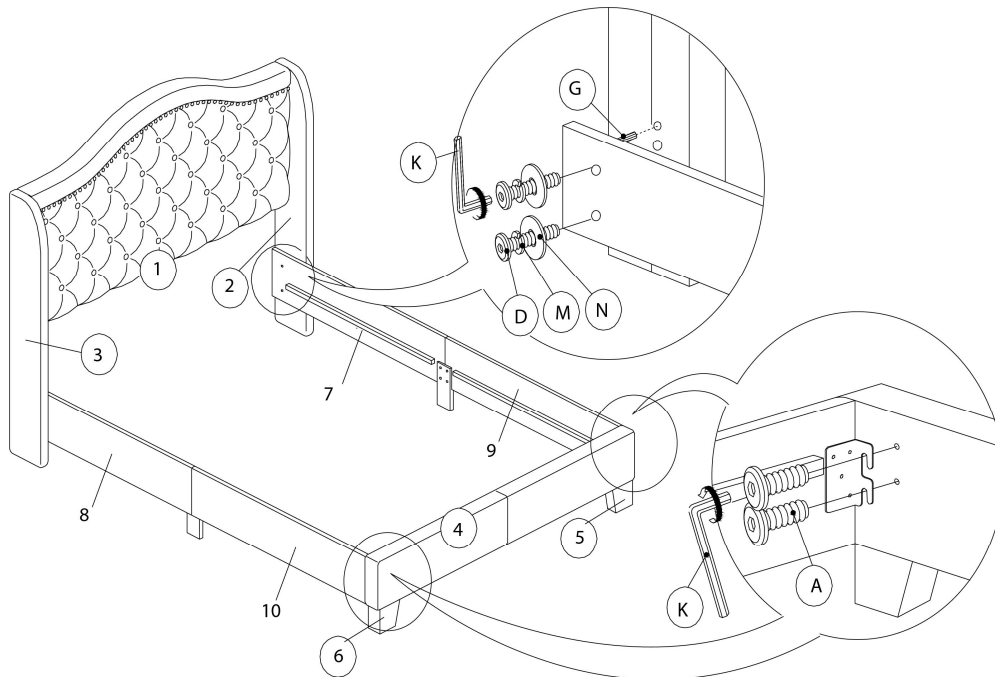

ÉTAPE / STEP 5

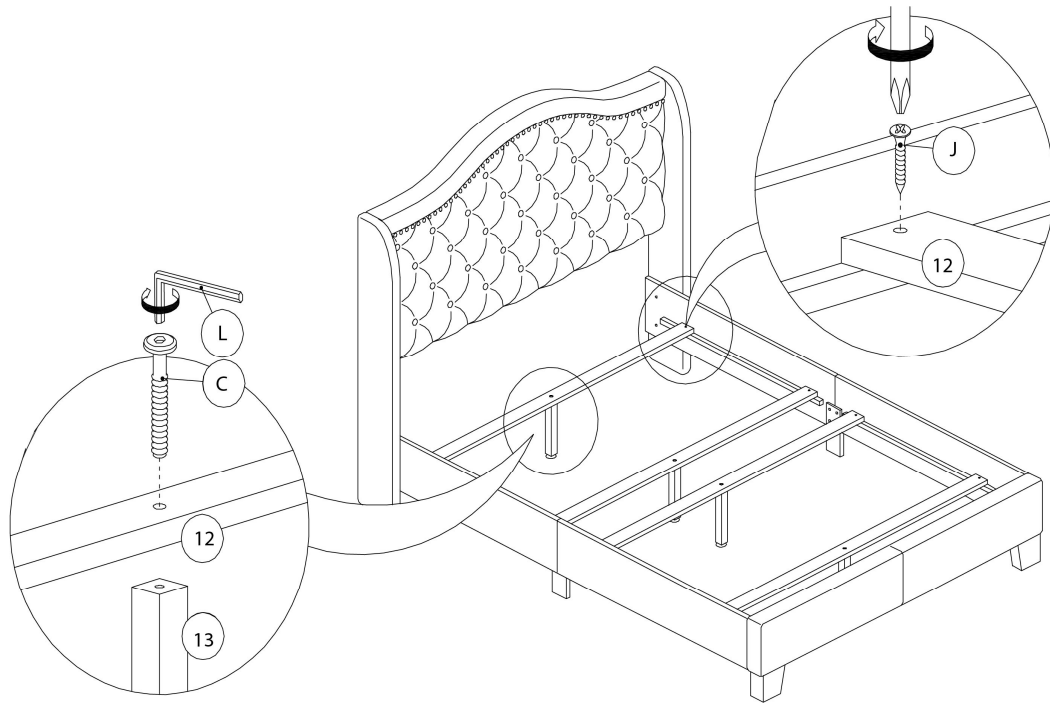

ÉTAPE / STEP 6

