

1

OPTION (01)
 Normal Position

OPTION (02)
 Highest Position

20min

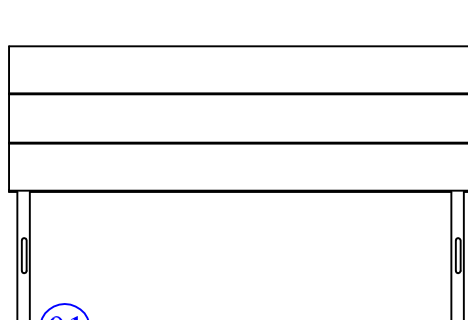
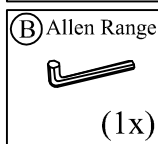
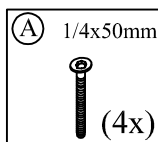
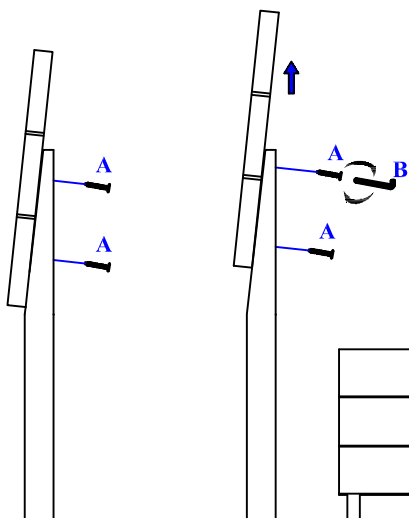

(01) Adjustment for when using only mattress (platform bed)

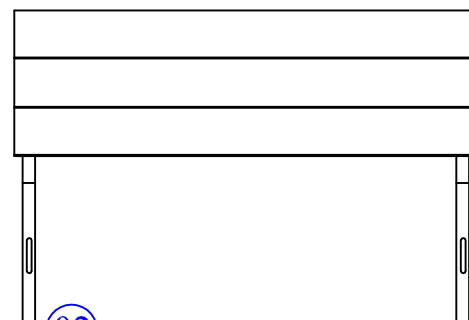

(02) Adjustment for when using box spring and mattress.

2

Center Support Slat

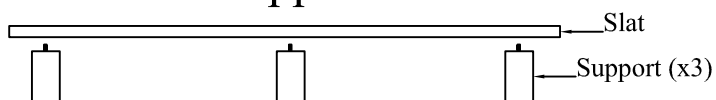

3

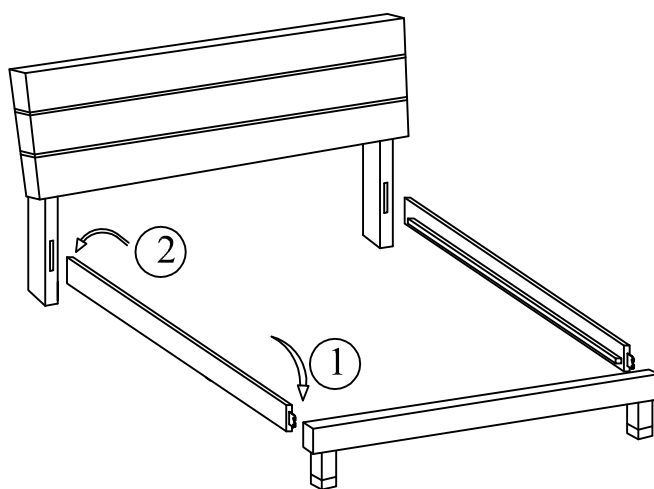

4

