







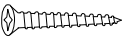

ASSEMBLY INSTRUCTION

CRWN 7945-13
QN PNL HDBD SKU # 33379454
CRWN 7945-17
QN PNL FTBD SKU # 33779452
CRWN 7945-19
QNKG RVS RAILS SKU # 33979456

Thank you for purchasing this quality product. Be sure to check all packing material carefully for small parts which may have come loose inside the carton during shipment. Identify and count all parts and compare with the Hardware List below.

Hardware List	No	Picture	Description	Dimension	Qty
	1		Allen Wrench	4 x 58mm	1
	2		JCBC Bolt (M6)	6 x P1.0 x 35mm	5
	3		CSK - Screw	3.5 x 32mm	10
	4		PHILIPS HEAD SCREWDRIVER (not included)		

Part List	No	Picture	Description	Qty
	A		Headboard	1
	B		Footboard	1
	C		Side Rail	2
	D		Slats	5
	E		Slat Support	5

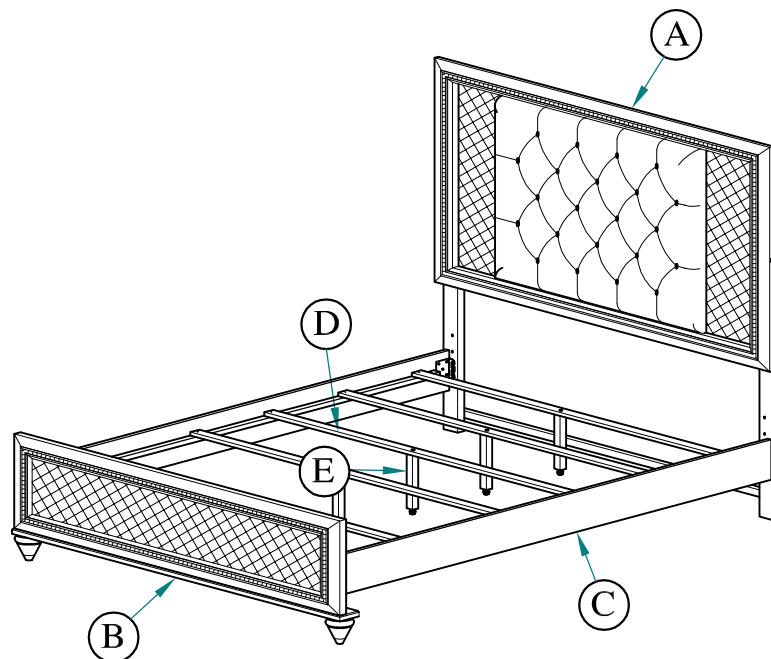

ASSEMBLY STEP

***Caution: Please read all instructions carefully before starting the assembly process. These parts are cumbersome and heavy. Therefore, two people are recommended in order to prevent personal injury and insure the parts are not damaged during the assembly.

2 options to assemble the slats :

Option 1

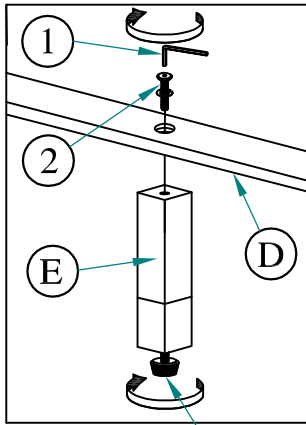

Attach (E) Slat Support Leg to the bottom of (D) Slat using (2) JCBC 35mm . Tighten the JCBC with (1) Allen wrench. Adjust the Adjustable leveler to level the bed with the floor.

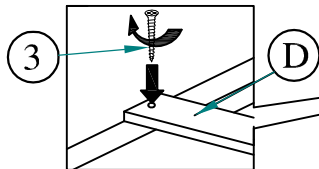

Secure the (D) Slat using the (3) Screw 32mm. Tighten the Screw with (4) Philip head screwdriver (not included)

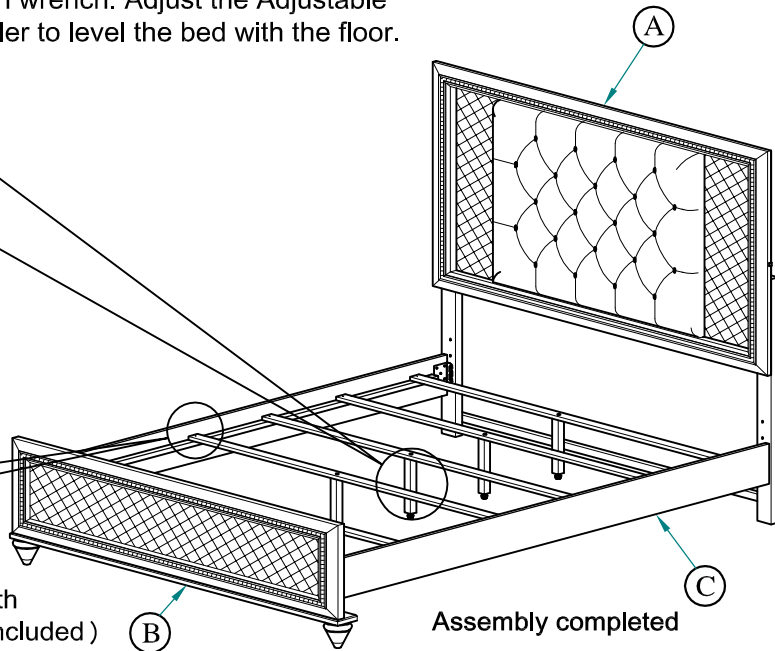

Option 2

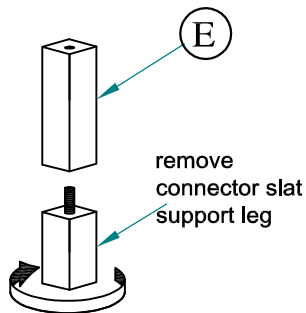

to assemble option 2, remove connector slat support leg.

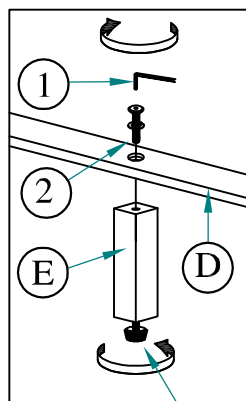

Attach (E) Slat Support Leg to the bottom of (D) Slat using (2) JCBC 35mm . Attach the Adjustable Leveler and adjust it to level the bed with the floor.

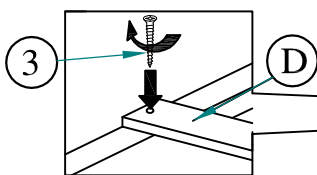

Secure the (D) Slat using the (3) Screw 32mm. Tighten the Screw with (4) Philip head screwdriver (not included)

