



# ASSEMBLY INSTRUCTION

PHOM SKU#: 356-150

5 DRAWER CHEST

33603564

Thank you for purchasing this quality product. Be sure to check all packing material carefully for small parts, which may have come loose inside the carton during shipment. Identify and count all parts and compare with the part list below.

No.	Parts List		
A		Drawer Chest	1 piece

Hardware List			
1		Tipping Restraint	1 piece

★ Remark: There is tip restraint kit provided on the back of this product. Please read the directions thoroughly and install immediately when placed in home.

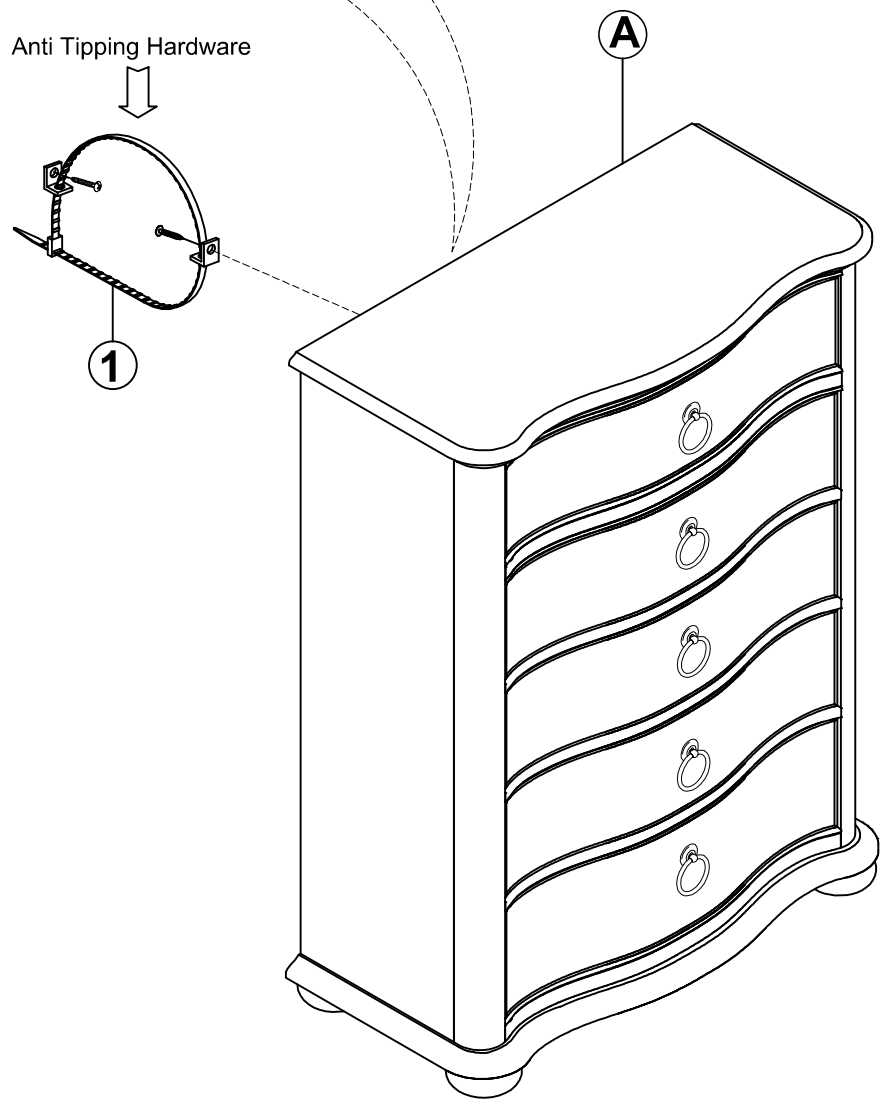

**CLEANING INSTRUCTION:** Clear with a soft cloth and warm water with a diluted mild detergent. Follow with a soft cloth and clear water rinse. Then dry thoroughly with a soft cloth.

MADE IN VIETNAM