

ALYSSA HOLLYWOOD MIRROR

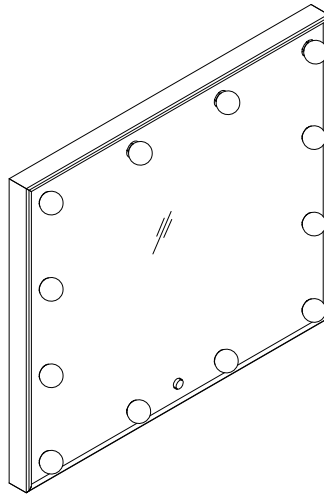

SKU#	STYLE	COLOR	DESCRIPTION
35675911	7591-177	WHITE	HOLLYWOOD MIRROR

3477591P - VANITY WITH SINGLE PEDESTAL WITH HOLLYWOOD MIRROR - WHITE		
SKU#	STYLE	DESCRIPTION
35175911	7591-170	VANITY - SINGLE CABINET
35475917	7591-174	VANITY - WOOD TOP
35675911	7591-177	HOLLYWOOD MIRROR

3447591P - VANITY WITH DOUBLE PEDESTAL WITH HOLLYWOOD MIRROR - WHITE		
SKU#	STYLE	DESCRIPTION
35375915	7591-173	VANITY - DOUBLE CABINET
35475917	7591-174	VANITY - WOOD TOP
35675911	7591-177	HOLLYWOOD MIRROR

3 OPTIONS TO ASSEMBLE LARGE SPARKLE MIRROR



3477591P - VANITY WITH SINGLE PEDESTAL WITH HOLLYWOOD MIRROR	3447591P - VANITY WITH DOUBLE PEDESTAL WITH HOLLYWOOD MIRROR	7591-122 - DRESSER SKU : 34175910 (Sold separately)

DO NOT USE SUBSTITUTE PARTS. PLEASE CONTACT YOUR RETAIL STORE OR WWW.ROOMSTOGO.COM
WITH SERVICE OR PARTS REPLACEMENT REQUEST.

This product is manufactured by RIEE for **ROOMS TO GO® | KIDS**

ALYSSA HOLLYWOOD MIRROR

HOLLYWOOD MIRROR PARTS LIST

	DESCRIPTION	IMAGE	Q'TY
A	HOLLYWOOD MIRROR		1 PC
B	MIRROR BRACKETS (L+R)		2 PCS
C	LIGHT BULB SINGLE COLOR (WHITE) (12V 1.8W)		12 PCS

HOLLYWOOD MIRROR PRE- ASSEMBLED HARDWARE LIST

	DESCRIPTION	IMAGE	Q'TY
2	(Ø1/4*20*1-1/2"L) BOLT		8 PCS
	(Ø1/4*13*1.2MM) SPRING WASHER		8 PCS
	(Ø1/4*19*1.8MM) FLAT WASHER		8 PCS
	(Ø1/4-18X10MM) THREADED WASHER		8 PCS

HARDWARE PACK LOCATION

SKU#	STYLE	COLOR	DESCRIPTION
35675911	7591-177	WHITE	MIRROR

HOLLYWOOD MIRROR HARDWARE LIST

	DESCRIPTION	IMAGE	Q'TY
1	(L57x4MM) ALLEN KEY		1 PC

IMPORTANT INSTRUCTIONS

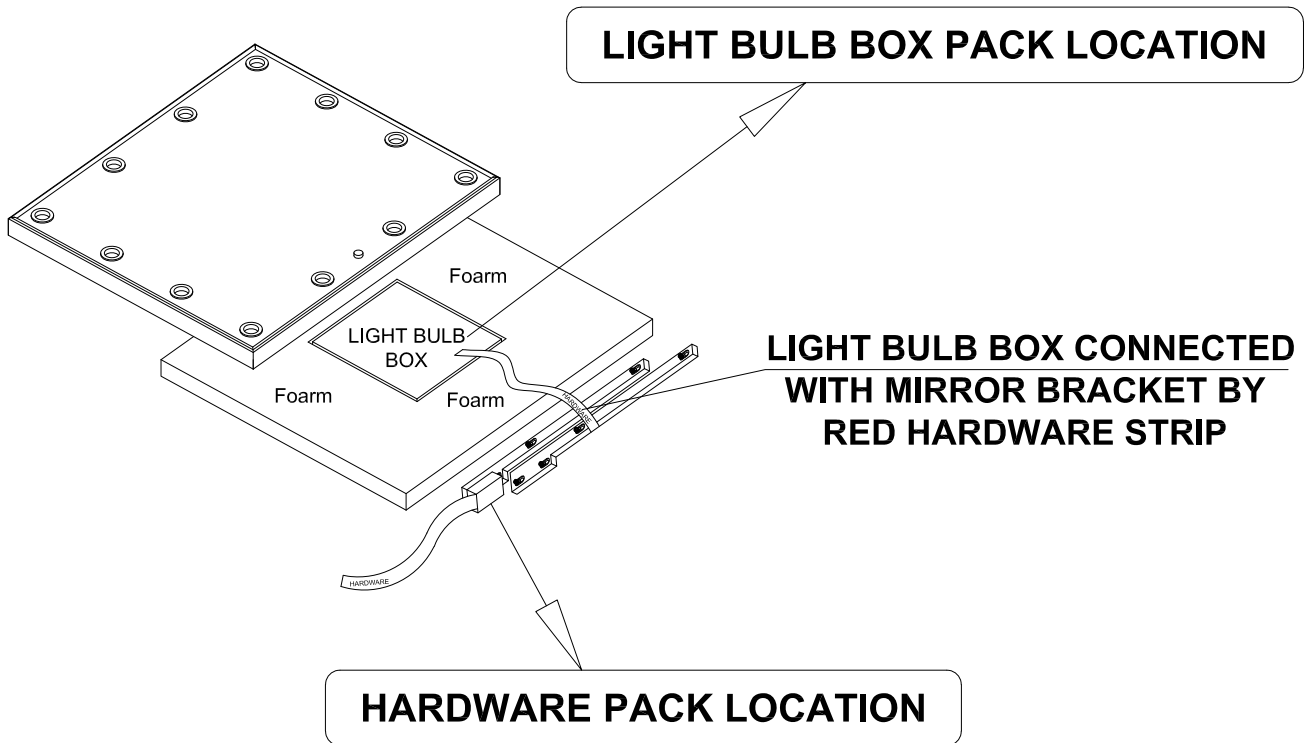

DO NOT USE SUBSTITUTE PARTS. PLEASE CONTACT YOUR RETAIL STORE OR WWW.ROOMSTOGO.COM WITH SERVICE OR PARTS REPLACEMENT REQUEST.

This product is manufactured by RIEE for **ROOMS TO GO® | KIDS**

ALYSSA
HOLLYWOOD MIRROR

Thank you for purchasing this quality product. Be sure to check all packing material carefully for small parts which may have come loose inside the carton during shipment. Identify and count all parts and compare with the parts list below. Read all instructions before assembling bed and keep these instructions for future reference.

Assembly instructions:

STEP 1

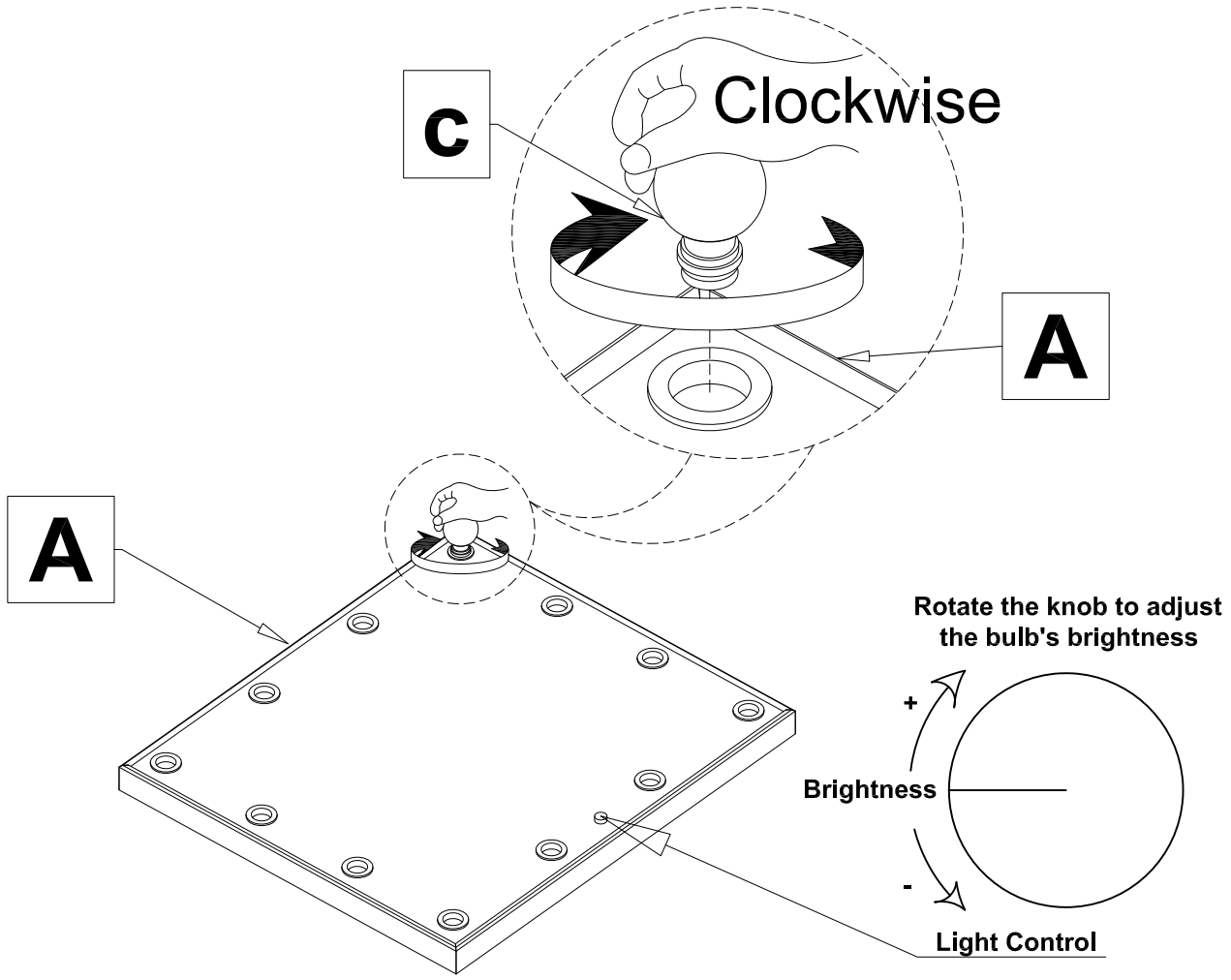

Attach the Light Bulb (C) to the sockets of Hollywood Mirror (A) clockwise

DO NOT USE SUBSTITUTE PARTS. PLEASE CONTACT YOUR RETAIL STORE OR WWW.ROOMSTOGO.COM WITH SERVICE OR PARTS REPLACEMENT REQUEST.

This product is manufactured by RIEE for **ROOMS TO GO® | KIDS**

ALYSSA HOLLYWOOD MIRROR + DRESSER

Thank you for purchasing this quality product. Be sure to check all packing material carefully for small parts which may have come loose inside the carton during shipment. Identify and count all parts and compare with the parts list below. Read all instructions before assembling bed and keep these instructions for future reference.

Assembly instructions:

Horizontal Hollywood Mirror + Dresser

STEP 2

1
Bolts are pre-installed on support rails

STEP 3 Sold separately

WARNING
Misuse can result in FIRE or DEATH by ELECTRICAL SHOCK

Light Control

Attach the Mirror Brackets (B) to the Hollywood Mirror (A) and Dresser . Tighten with Allen Bolts, Spring Washers, Flat Washers and Threaded Washers(2) with Allen Key provided (1) by screwing them into place.

Vertical Hollywood Mirror + Dresser

STEP 2

1
Bolts are pre-installed on support rails

STEP 3 Sold separately

WARNING
Misuse can result in FIRE or DEATH by ELECTRICAL SHOCK

Light Control

Attach the Mirror Brackets (B) to the Hollywood Mirror (A) and Dresser . Tighten with Allen Bolts, Spring Washers, Flat Washers and Threaded Washers(2) with Allen Key provided (1) by screwing them into place.

DO NOT USE SUBSTITUTE PARTS. PLEASE CONTACT YOUR RETAIL STORE OR WWW.ROOMSTOGO.COM WITH SERVICE OR PARTS REPLACEMENT REQUEST.

This product is manufactured by RIEE for **ROOMS TO GO® | KIDS**

ALYSSA

VANITY W/ SINGLE PEDESTAL W/ HOLLYWOOD MIRROR

Thank you for purchasing this quality product. Be sure to check all packing material carefully for small parts which may have come loose inside the carton during shipment. Identify and count all parts and compare with the parts list below. Read all instructions before assembling bed and keep these instructions for future reference.

Assembly instructions:

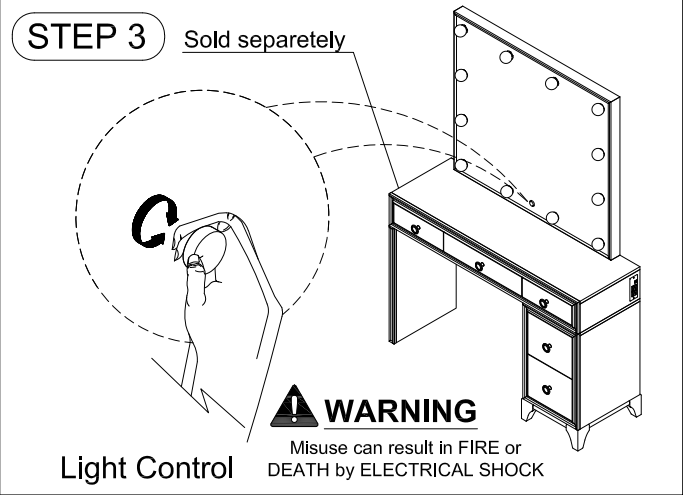
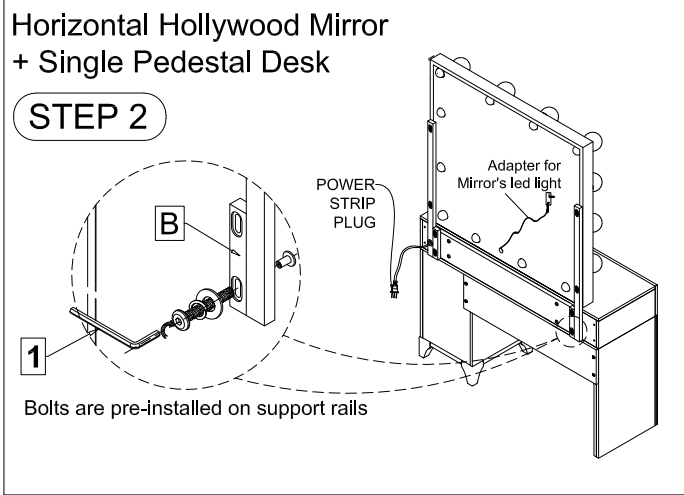

Attach the Mirror Brackets (B) to the Hollywood Mirror (A) and Single Pedestal Desk . Tighten with Allen Bolts, Spring Washers, Flat Washers and Threaded Washers(2) with Allen Key provided (1) by screwing them into place.

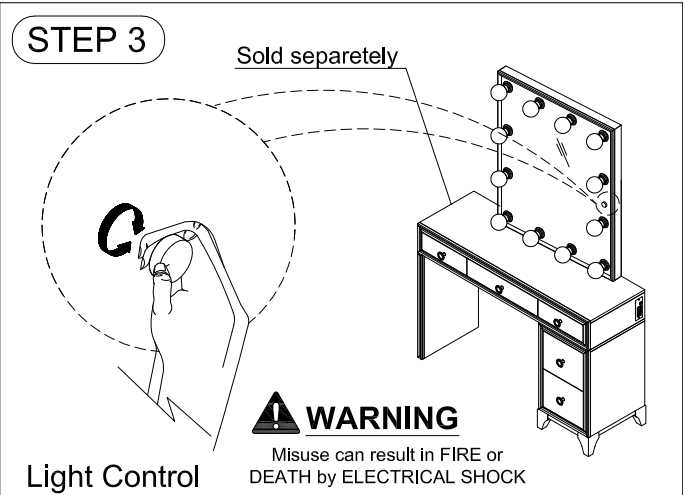
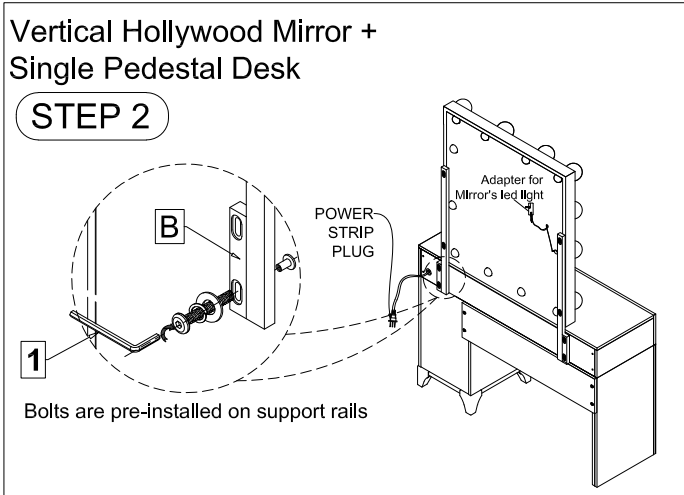

Attach the Mirror Brackets (B) to the Hollywood Mirror (A) and Single Pedestal Desk . Tighten with Allen Bolts, Spring Washers, Flat Washers and Threaded Washers(2) with Allen Key provided (1) by screwing them into place.

DO NOT USE SUBSTITUTE PARTS. PLEASE CONTACT YOUR RETAIL STORE OR WWW.ROOMSTOGO.COM WITH SERVICE OR PARTS REPLACEMENT REQUEST.

This product is manufactured by RIEE for **ROOMS TO GO® | KIDS**

ALYSSA

VANITY W/ DOUBLE PEDESTAL W/ HOLLYWOOD MIRROR

Thank you for purchasing this quality product. Be sure to check all packing material carefully for small parts which may have come loose inside the carton during shipment. Identify and count all parts and compare with the parts list below. Read all instructions before assembling bed and keep these instructions for future reference.

Assembly instructions:

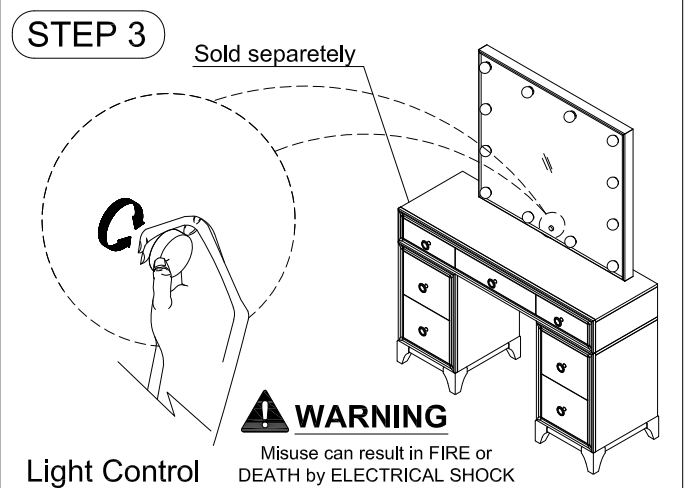
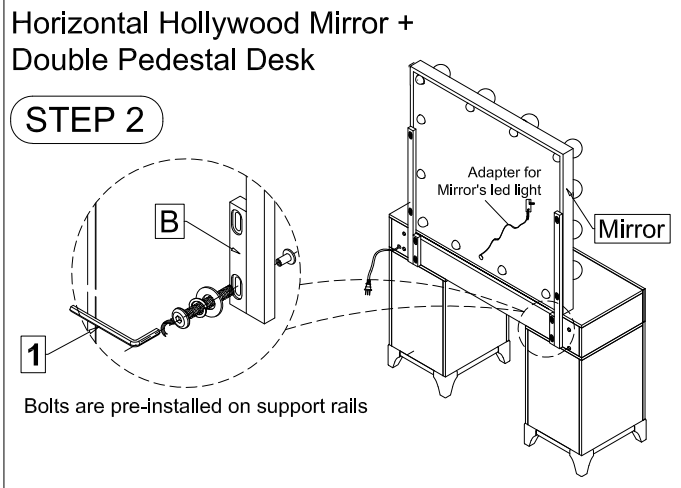

Attach the Mirror Brackets (B) to the Hollywood Mirror (A) and Double Pedestal Desk. Tighten with Allen Bolts, Spring Washers, Flat Washers and Threaded Washers(2) with Allen Key provided (1) by screwing them into place.

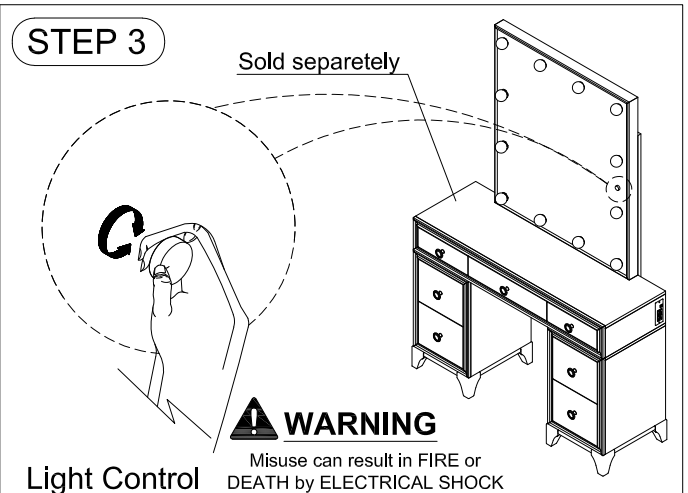
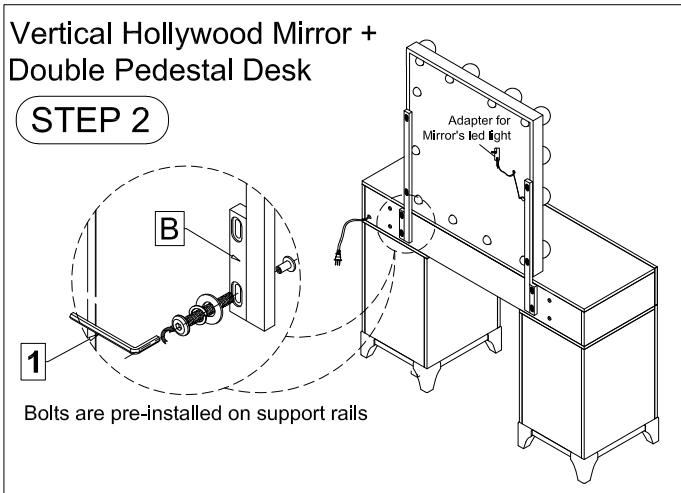

Attach the Mirror Brackets (B) to the Hollywood Mirror (A) and Double Pedestal Desk. Tighten with Allen Bolts, Spring Washers, Flat Washers and Threaded Washers(2) with Allen Key provided (1) by screwing them into place.

DO NOT USE SUBSTITUTE PARTS. PLEASE CONTACT YOUR RETAIL STORE OR WWW.ROOMSTOGO.COM WITH SERVICE OR PARTS REPLACEMENT REQUEST.

This product is manufactured by RIEE for **ROOMS TO GO® | KIDS**

ALYSSA
HOLLYWOOD MIRROR

Thank you for purchasing this quality product. Be sure to check all packing material carefully for small parts which may have come loose inside the carton during shipment. Identify and count all parts and compare with the parts list below. Read all instructions before assembling bed and keep these instructions for future reference.

Light bulb Replacement Instructions:

STEP 1

IMPORTANT: Unplug the mirror's adapter from the electrical outlet, then allow the mirror's bulb to cool

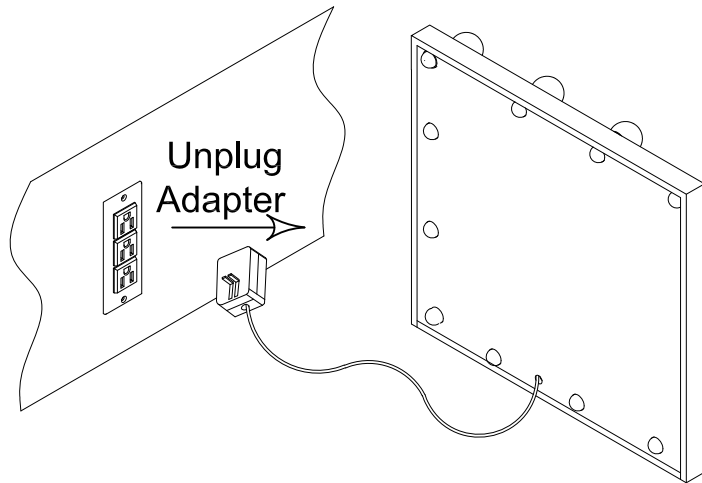

STEP 2

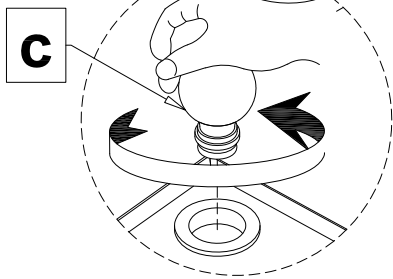

Remove the old bulb by turning it counterclockwise.

STEP 3

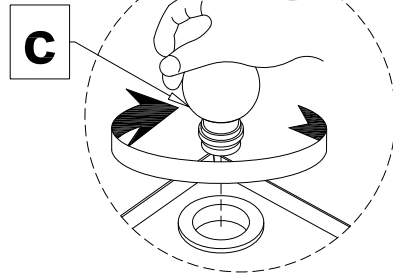

Insert the new bulb into the sockets and turn it clockwise until secure. (LED Light Bulb Specifications: 12V 1.8W; Screw base)

STEP 4

Recheck all bulbs to make sure they are secured before use. Dispose of the old bulb safely.

DO NOT USE SUBSTITUTE PARTS. PLEASE CONTACT YOUR RETAIL STORE OR WWW.ROOMSTOGO.COM WITH SERVICE OR PARTS REPLACEMENT REQUEST.

This product is manufactured by RIEE for **ROOMS TO GO® | KIDS**

IMPORTANT SAFETY INSTRUCTIONS



WARNING

Misuse can result in FIRE or DEATH by ELECTRICAL SHOCK

[ELECTRICAL RATING (12V/2A/24Watts)]

[Eye Technology Co., Ltd]

[FX24U -120200C]

Read all instructions before using this furnishing.

DANGER - To reduce the risk of electric shock:

1. Always unplug this furnishing from the electrical outlet before cleaning or servicing.

WARNING - To reduce the risk of burns, fire, electric shock, or injury to persons:

1. Unplug from outlet before putting on or taking off parts.
2. Never operate this furnishing if it has a damaged electrical cord or plug, if it is not working properly, or if the electrical cord or plug has been damaged or dropped into water. Stop using this furnishing and call a service center for examination and repair.
3. Keep the electrical cord and plug away from heated surfaces and other heat sources.
4. To disconnect, turn all controls to the off position, then remove plug from outlet.
5. When operating, ensure that electrical cord is not under the base, legs, or motion mechanism to avoid damage to electrical cord or plug.
6. Do not strain or stretch electrical cord.
7. Do not use extension cords or power strips.
8. Keep out of reach of children. This is not a toy.
9. Plug directly into a compatible electrical socket.
10. Do not modify the plug or use any adapters.

INSTRUCCIONES DE SEGURIDAD IMPORANTES



WARNING

El mal uso puede provocar INCENDIO o MUERTE por DESCARGA ELÉCTRICA

[CLASIFICACION ELECTTRICA (12V/2A/24Watts)]

[Eye Technology Co., Ltd]

[FX24U -120200C]

Leer todas las instrucciones antes de usar este mobiliario.

PELIGRO - Para reducir el riesgo de descarga electrica:

1. Siempre desenchufe este accesorio de la toma de corriente eléctrica antes de limpiarlo o repararlo.

ADVERTENCIA: para reducir el riesgo de quemaduras, incendios, descargas eléctricas o lesiones a personas:

1. Desenchufe del tomacorriente antes de colocar o quitar partes.
2. Nunca opere este accesorio si tiene un cable o enchufe eléctrico dañado, si no funciona correctamente, o si el cable o el enchufe eléctrico se ha dañado o se ha caído al agua. Deje de usar este equipamiento y llame a un centro de servicio para que lo examinen y lo reparen.
3. Mantenga el cable eléctrico el enchufe lejos de superficies calientes y otras fuentes de calor.
4. Para desconectar, gire todos los controles a la posición de apagado, luego retire el enchufe del tomacorriente.
5. Al operar, asegúrese de que el cable eléctrico no esté debajo de la base, las patas o el mecanismo de movimiento para evitar dañar el cable eléctrico o el enchufe.
6. No fuerce ni estire el cable eléctrico.
7. No utilizar cables de extensión o tomas de corriente.
8. Mantener fuera del alcance de los niños. Esto no es un juguete.
9. Enchúfelo directamente a una toma de corriente compatible.
10. No modifique el enchufe ni utilice adaptadores.