

ASSEMBLY INSTRUCTIONS

3225TT - Twin Twin Tower Bunk

Thank you for purchasing this quality product. Be sure to check all packing materials carefully for small parts which may have come loose inside the carton during shipment. Separate, identify and count all parts and hardware. Compare with the parts list to be sure all parts are present.

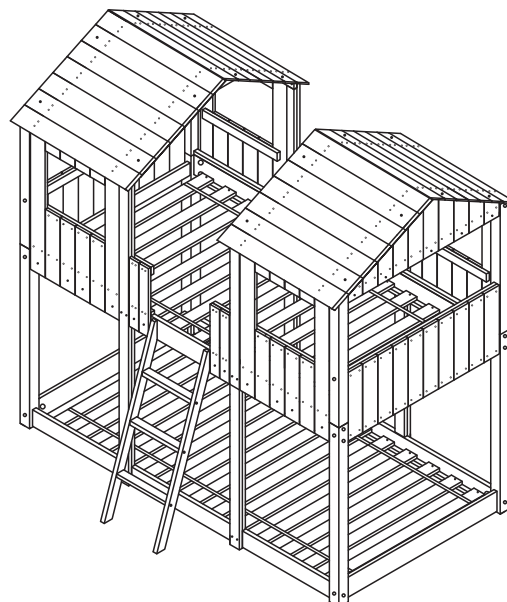

**“DO NOT TIGHTEN SCREWS
UNTIL COMPLETELY ASSEMBLED”**

SIZE OF MATTRESS AND FOUNDATION (SUPPORT)

This bed is designed to use a twin mattress (37½”-38½”x74-75”) and bunkie board (37½”x74”). The total thickness must not exceed **8”** inches. Do not use mattress without the proper bunkie board of safe foundation.

Note: There must be at least **5”** inches from top surface of mattress to top edge of guardrails.

REPLACEMENT PARTS.

Replacement parts, including additional guardrails, may be obtained from place of purchase or original distributor.

TO OBTAIN PARTS ,PLEASE CONTACT: **DONCO TRADING COMPANY - FORT WORTH, TEXAS**

SAFETY WARNINGS!

- 1- Follow the information on the warning label appearing on the upper bunk end structure and on the carton. Do not remove warning label from bed.
- 2- Always use the recommended size mattress or mattress support, or both, to help prevent the likelihood of entrapment or falls.
- 3- Surface of mattress must be at least 5 inches below the upper edge of guardrails.
- 4- Do not allow children under 6 years of age to use the upper bunk.
- 5- Prohibit more than one person on upper bunk.
- 6- Periodically check and ensure that the guardrail, ladder and other components are in their proper position, free from damage, and that all connectors are tight.
- 7- Do not allow horseplay on or under the bed and prohibit jumping on the bed.
- 8- Always use the ladder for entering and leaving the upper bunk.
- 9- Do not use substitute parts. Contact manufacturer or dealer for replacement parts.
- 10- Use of a night light may provide added safety precaution for a child using the upper bunk.
- 11- If the bunk bed will be placed next to a wall, the guardrail that runs the full length of the bed should be placed against the wall to prevent entrapment between the bed and the wall.
- 12- Always use guard rails on both long sides of the upper bunk.
- 13- The use of water or sleep flotation mattresses is prohibited.
- 14- Keep these instructions for future reference.
- 15- Strangulation Hazard - Never attach or hang items to any part of the bunk bed that are not designed for use with the bed: for example, but not limited to, hooks, belts, and jump ropes, etc.

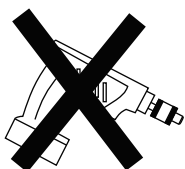

!
* Use of power tool to assemble this product will invalidate any claim and damage this product making unsafe !!!
* Please assemble on a clean soft surface to avoid damage.

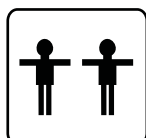

+



Tools Required

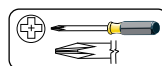

(Not included)

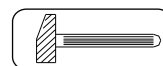

(Not included)



IMPORTANT: PLEASE READ INSTRUCTIONS BEFORE STARTING THE ASSEMBLY

Part List: 3225TT - Twin Twin Tower Bunk



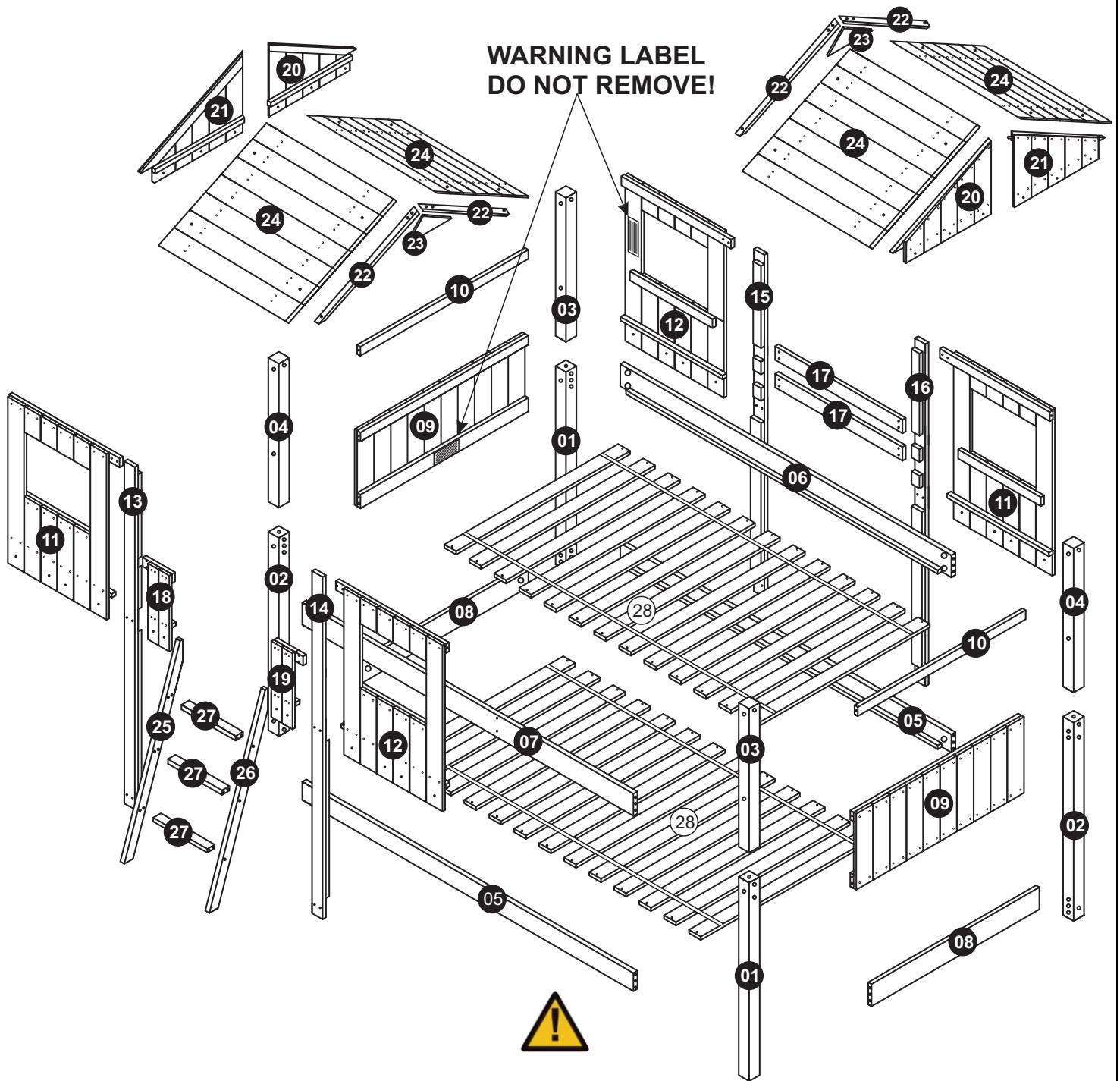





**WARNING LABEL
DO NOT REMOVE!**

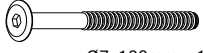

CAUTION!

*Please be careful when assembling this product due the parts are extremely heavy.
Also, please do not allow kids around when assembling this bed to avoid injuries!*

Identifying the Hardware-Identify the hardware using the illustrations below.



A	 Ø10x40mm	38	D	 Ø4,0x40mm	08	G	 4mm	01
B	 Ø1/4"x110mm - Ø17	16	E	 Ø7x100mm - 17	16	H	 Ø4,0x30mm BLACK	88
C	 Ø1/4"x25mm	16	F	 Ø3,5x30mm	52	I	 Ø7x60mm - 17	10

01

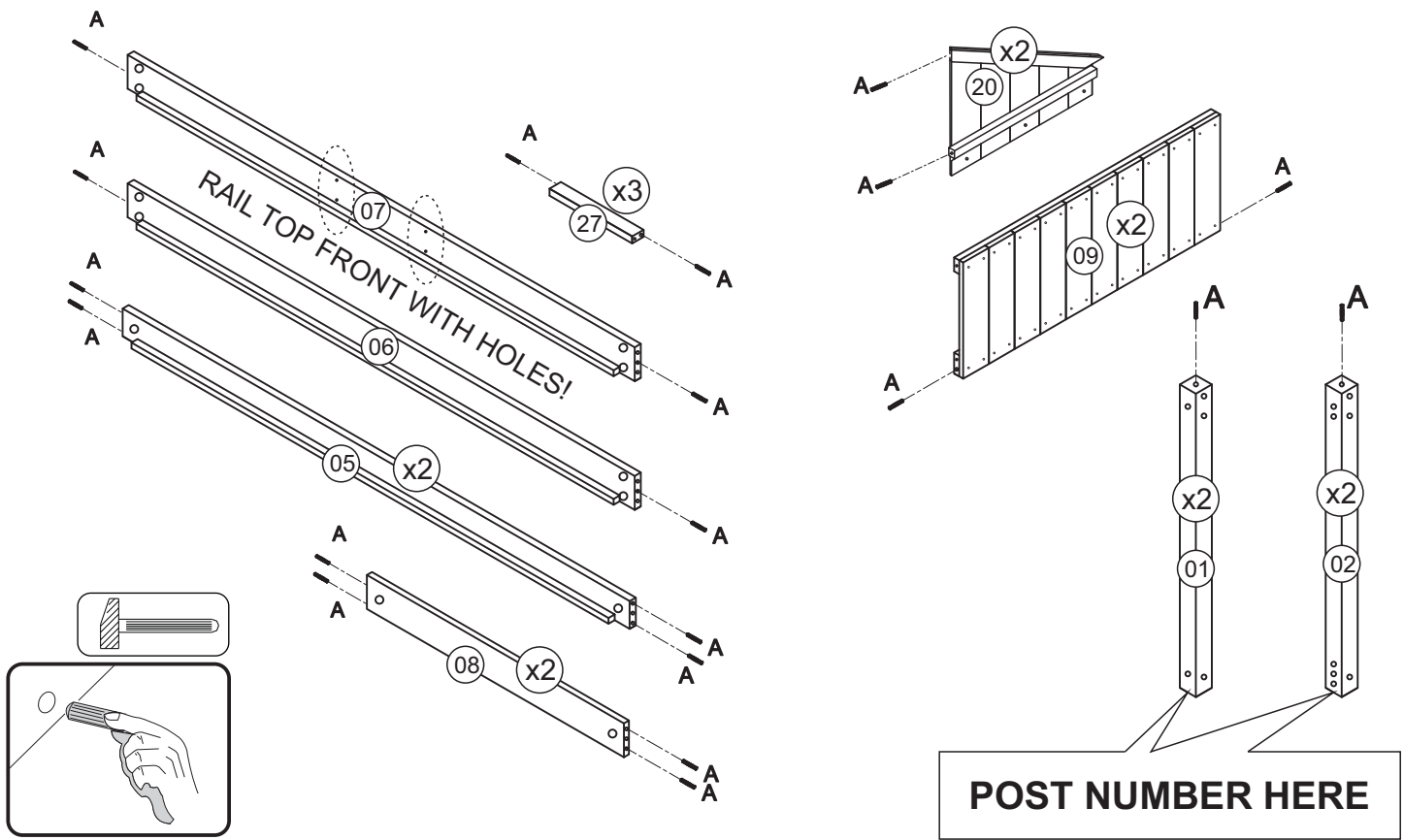
A		38
	Ø10x40mm	

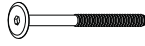

02

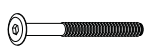
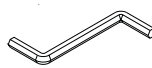
B		04	C		04
	Ø1/4"x110mm - Ø17			Ø1/4"x25mm	
E		12	G		01
	Ø7x100mm - 17			4mm	

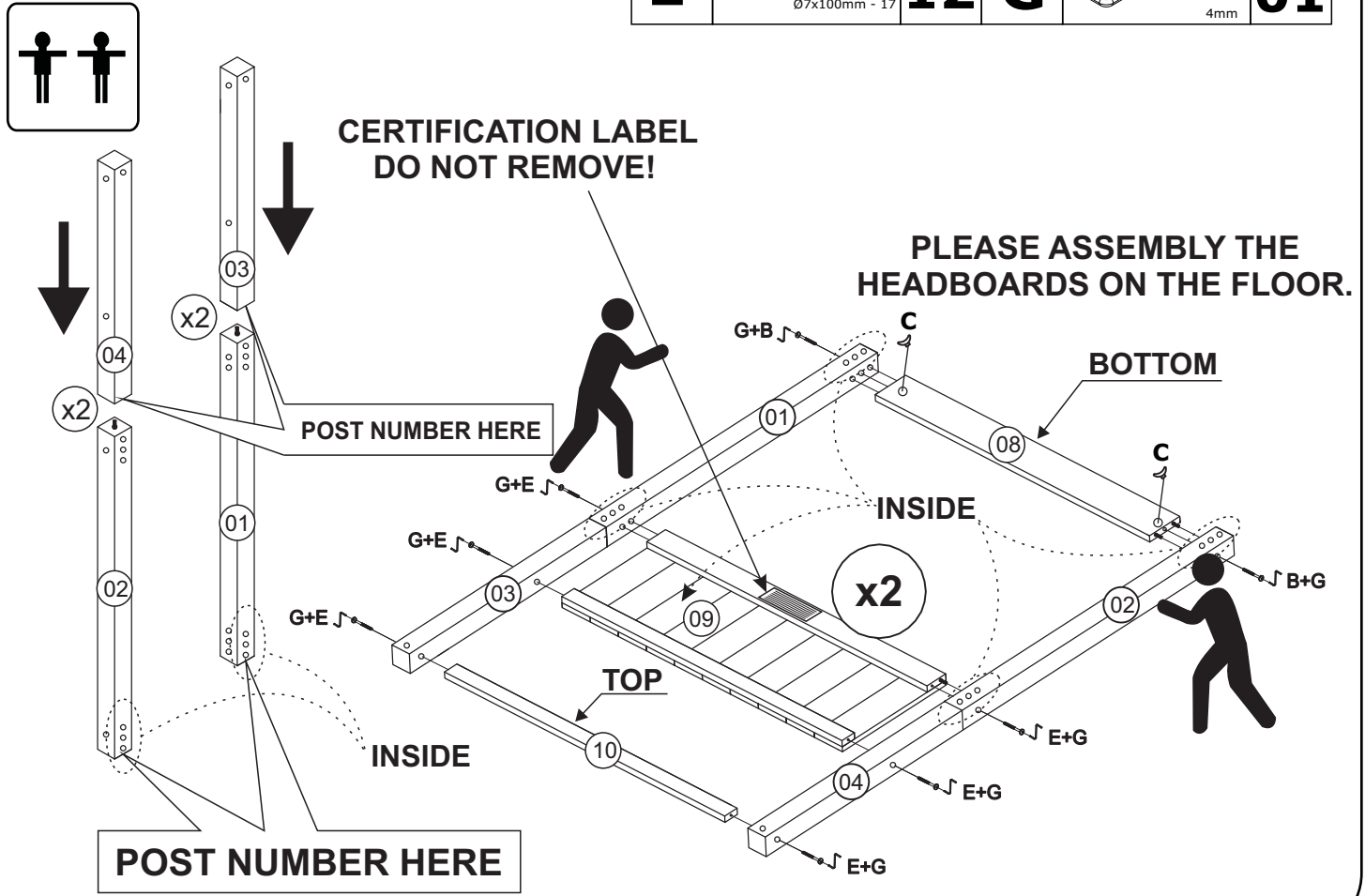

03

B

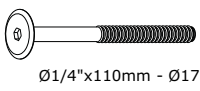

04 C



04 G

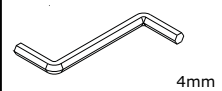

01

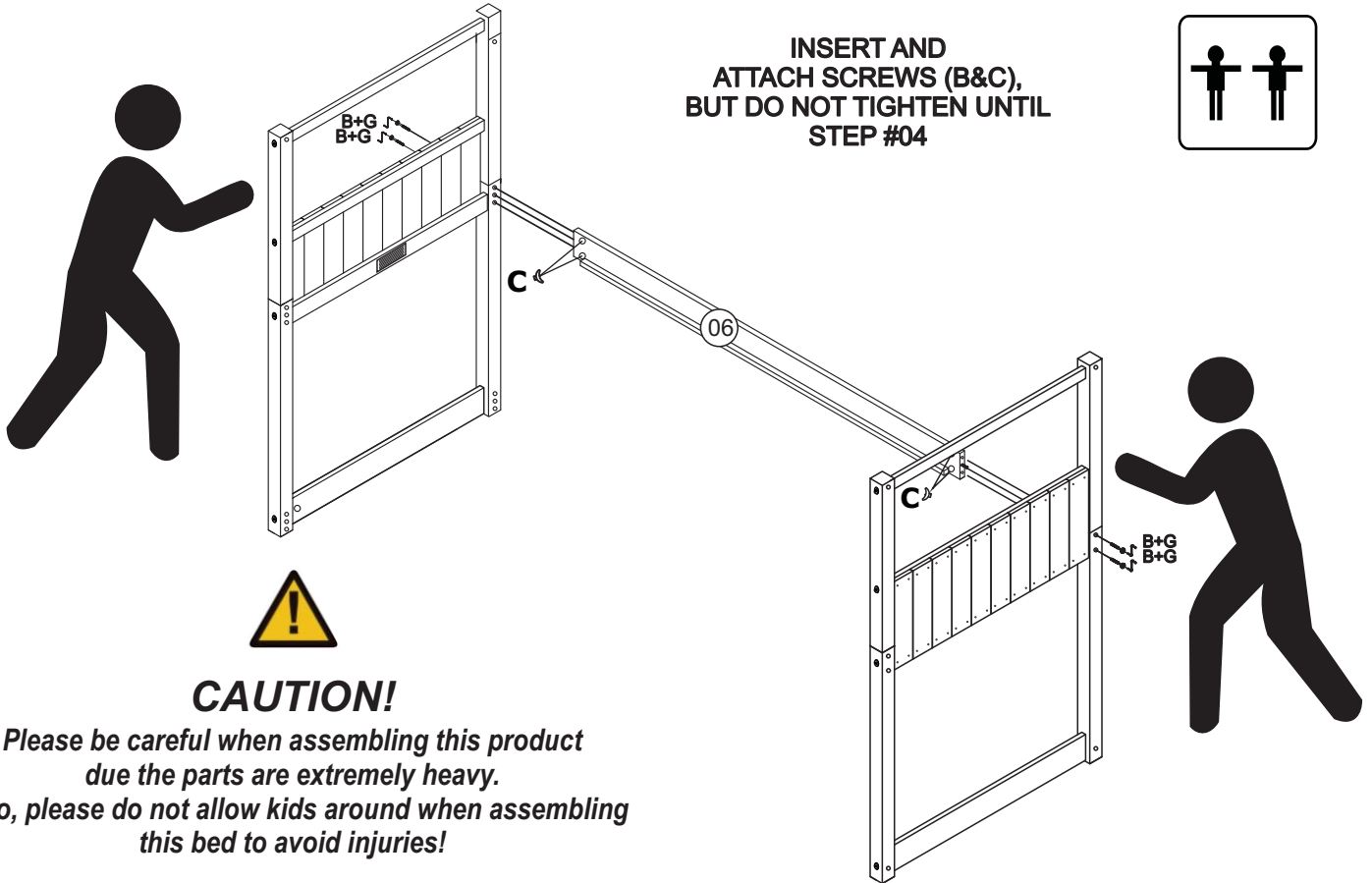

04

B

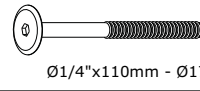

08 C

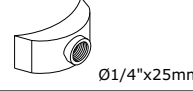

08 G

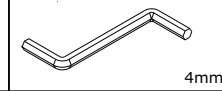

01

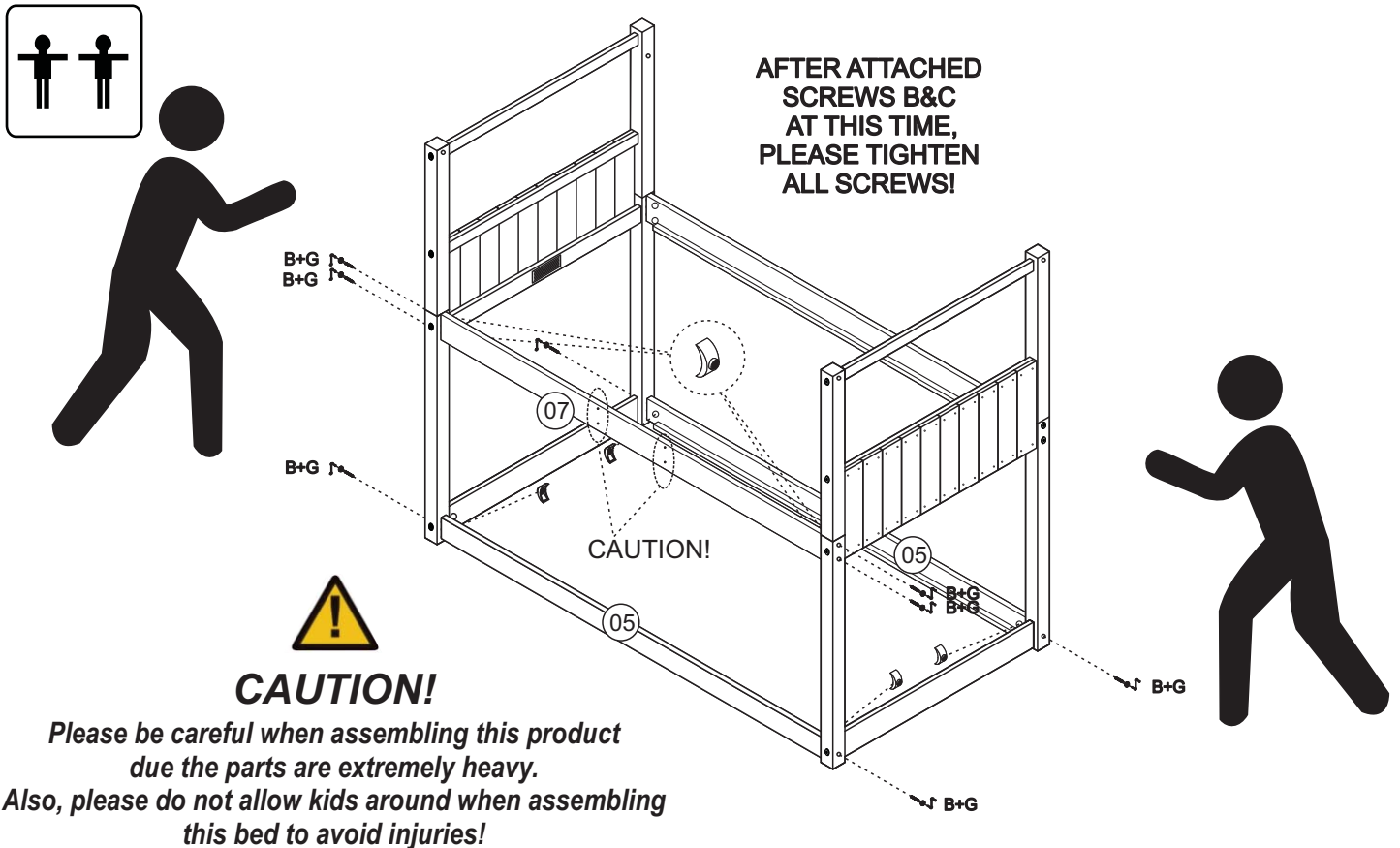

05



E	 Ø7x100mm - 17	04	G	 4mm	01
----------	---	-----------	----------	---	-----------

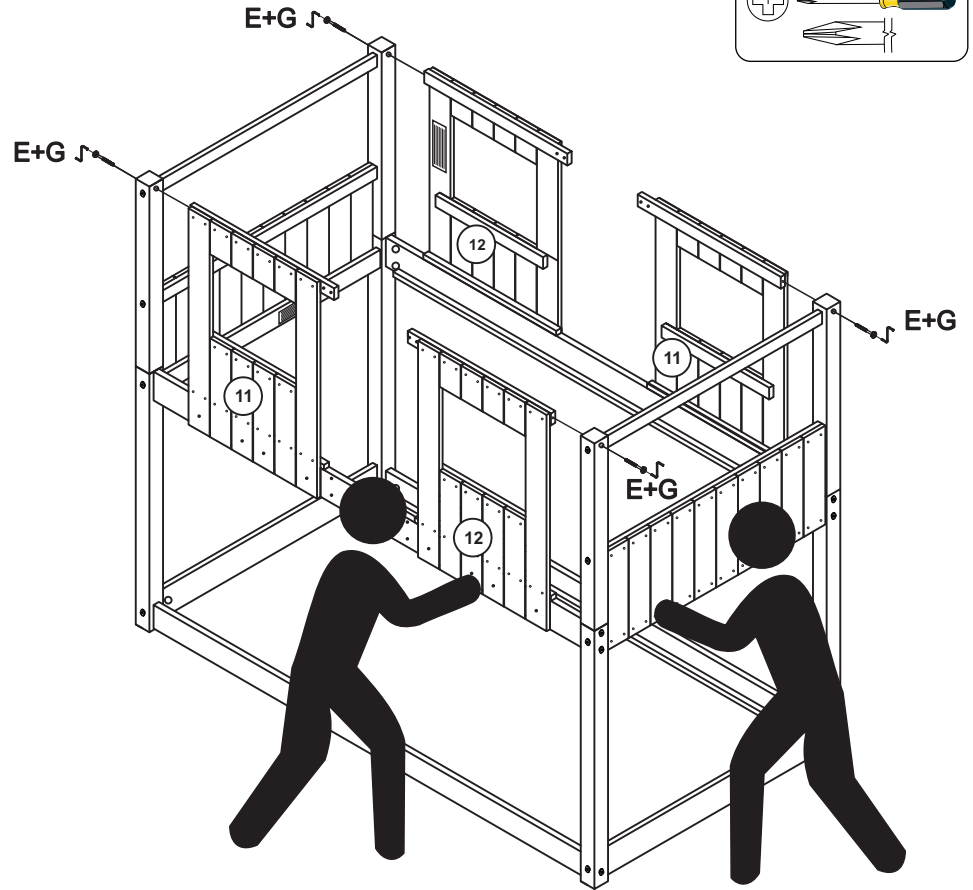
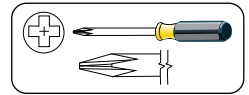

06



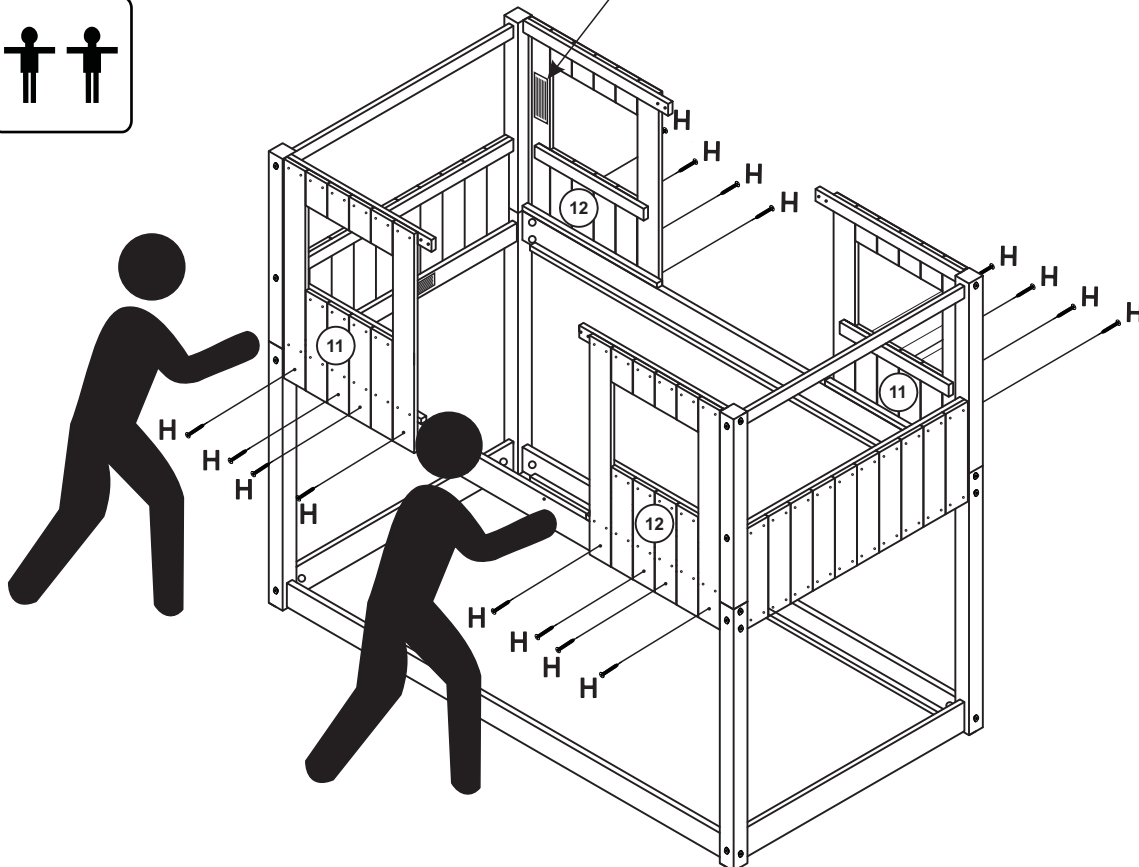
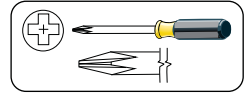

**WARNING LABEL
DO NOT REMOVE!**

H	 Ø4,0x30mm BLACK	16
----------	--	-----------

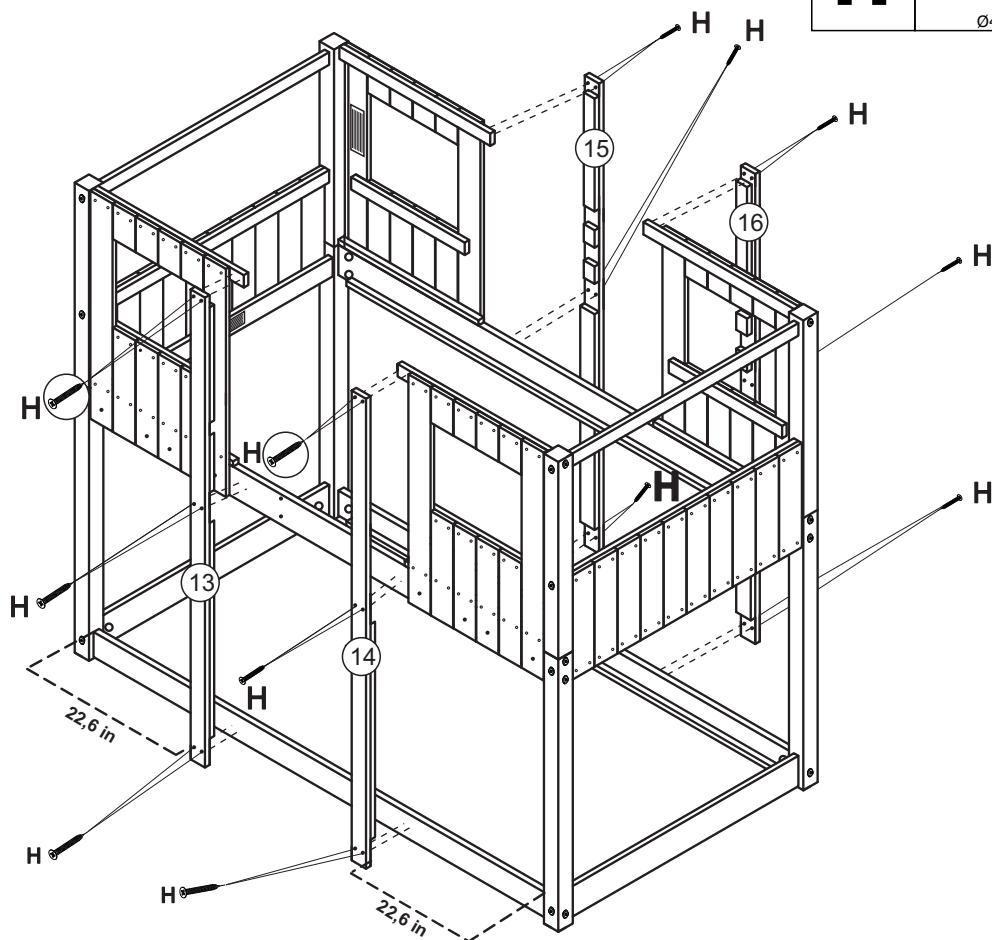
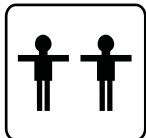

07



H	 Ø4,0x30mm BLACK	24
----------	--	-----------

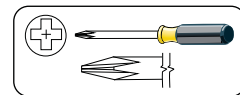

08

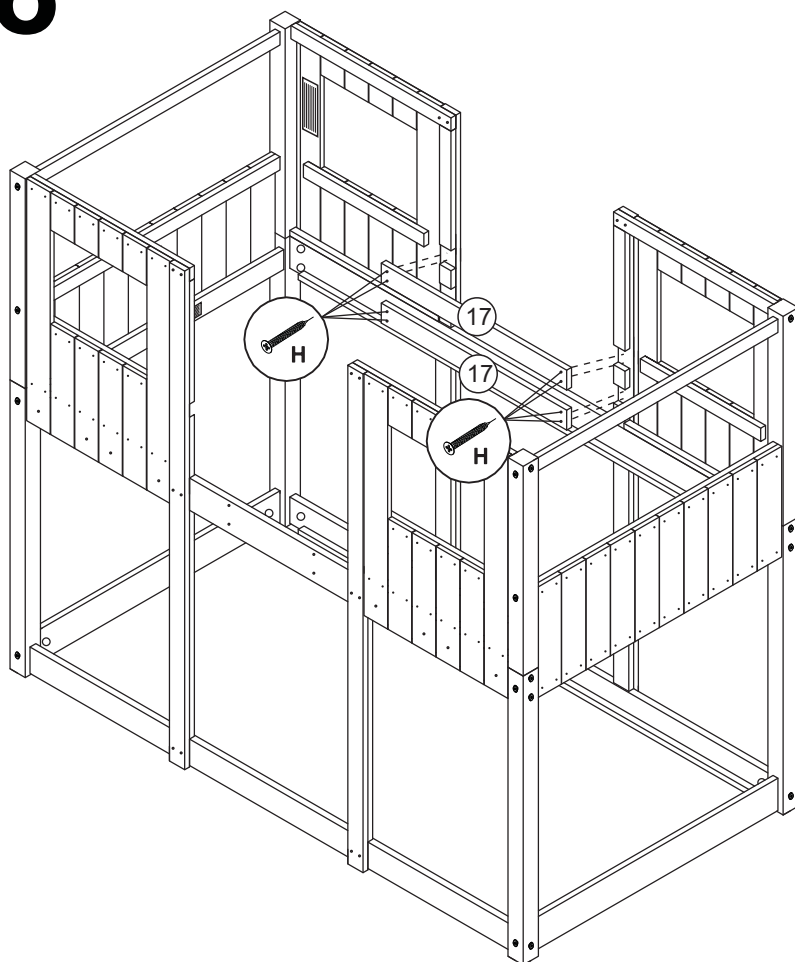

H	 Ø4,0x30mm BLACK	08
----------	--	-----------

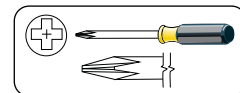

09

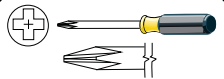
H	 Ø4,0x30mm BLACK	08
		

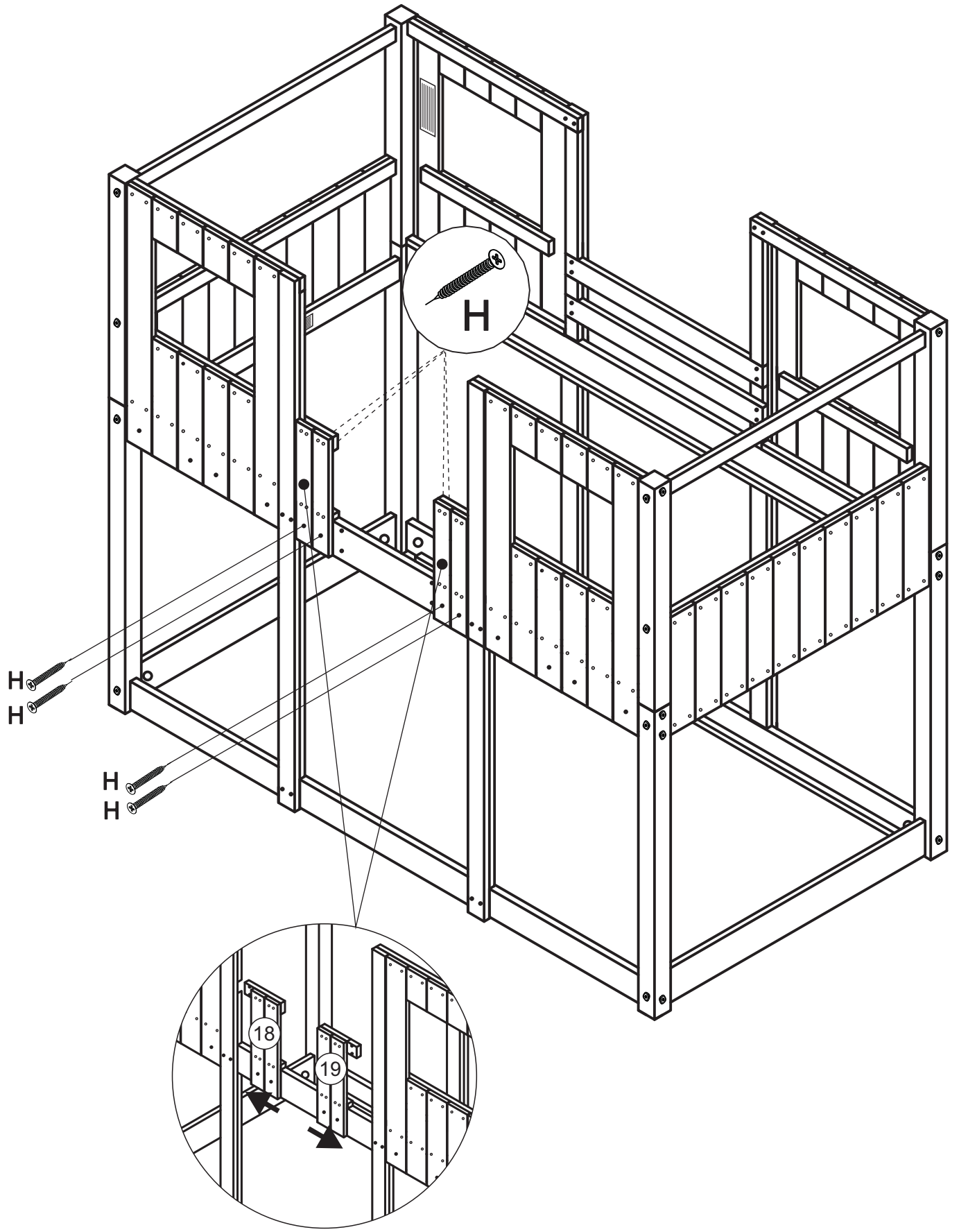

10

H



Ø4,0x30mm BLACK

12



**WARNING LABEL
DO NOT REMOVE!**

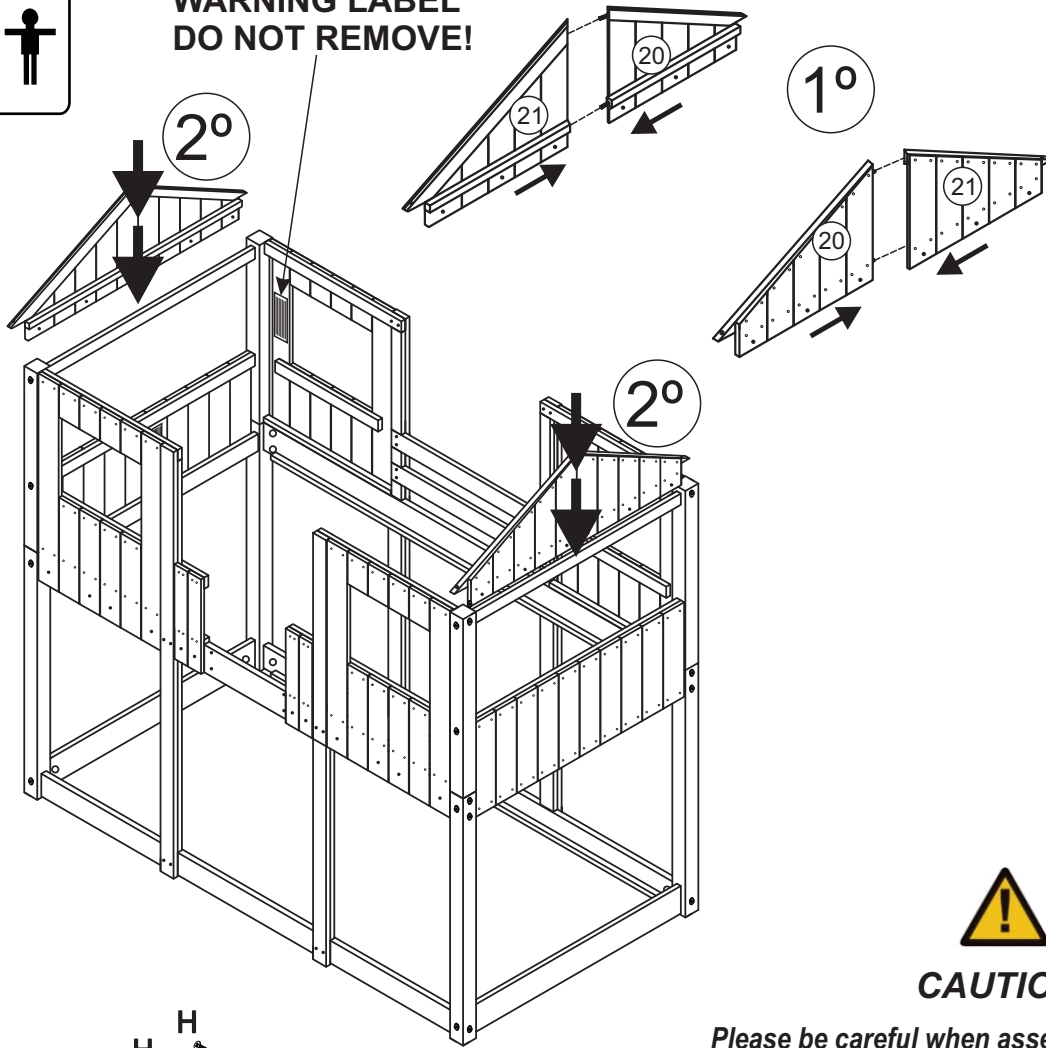
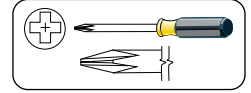

CAUTION!

Please be careful when assembling this product due the parts are extremely heavy. Also, please do not allow kids around when assembling this bed to avoid injuries!

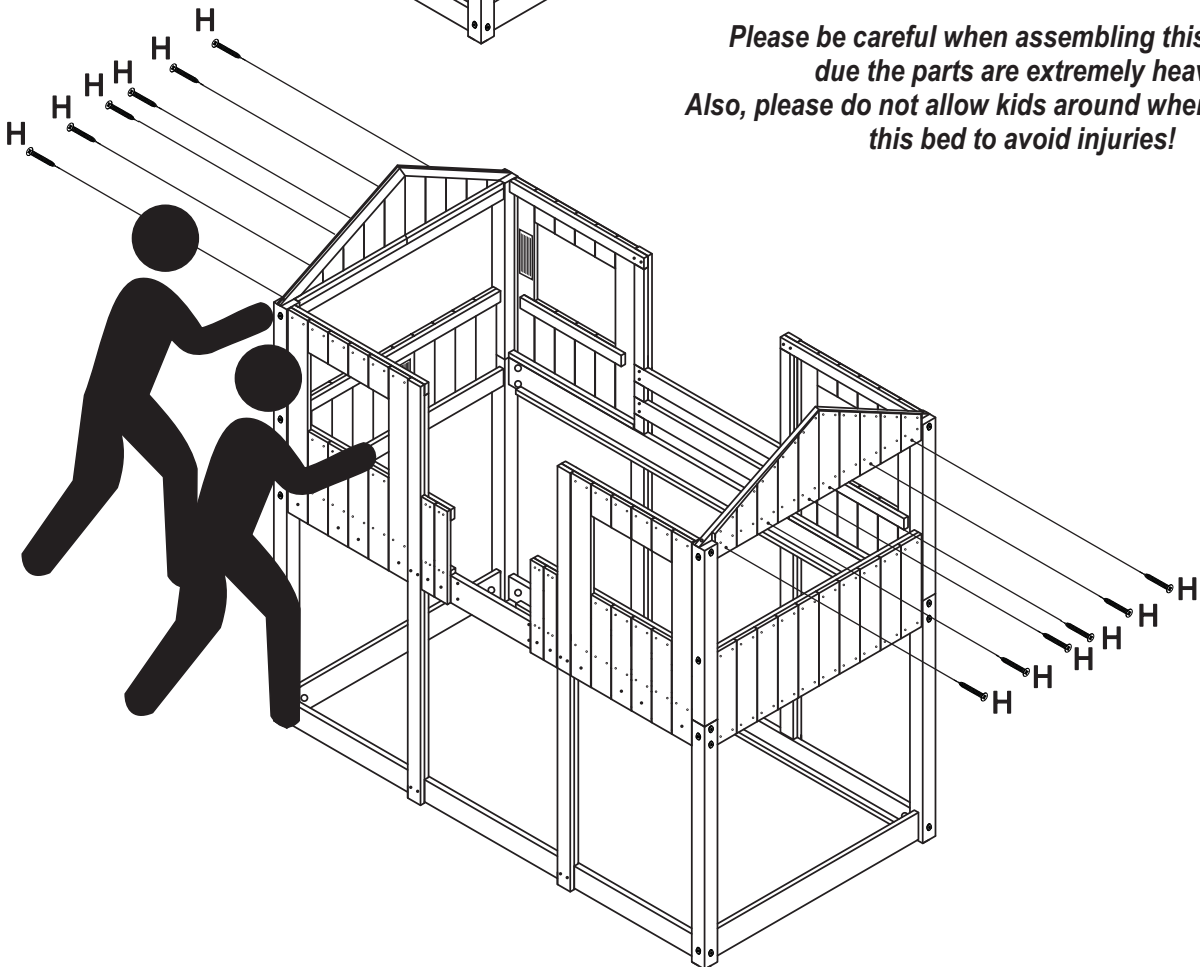

11

D

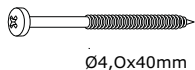

08 H

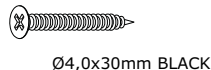

04

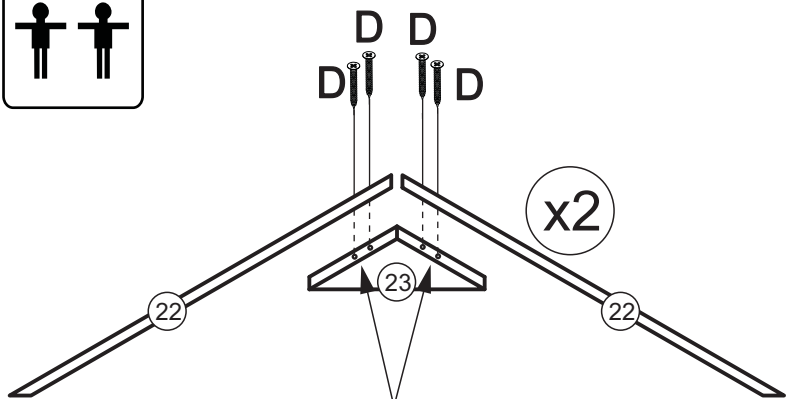
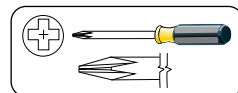
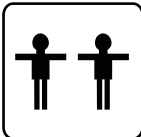

PRE-HOLES

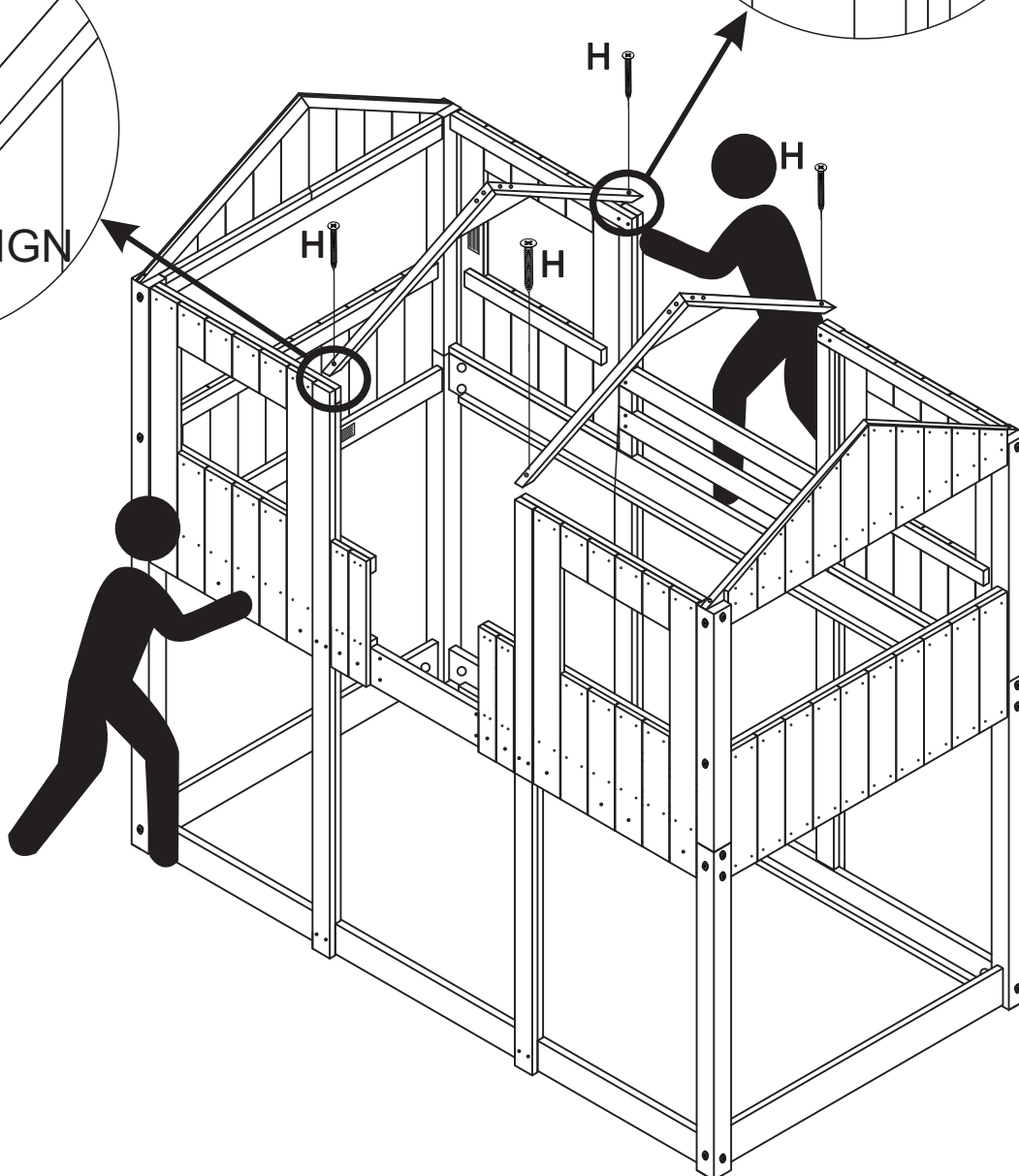
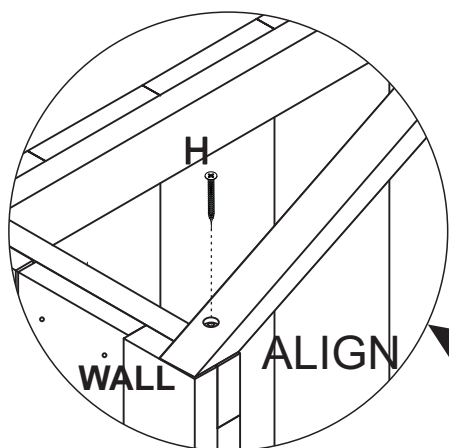
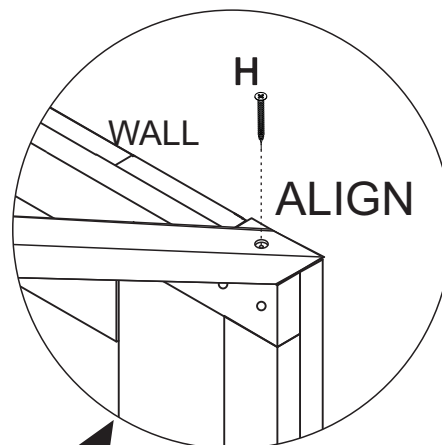
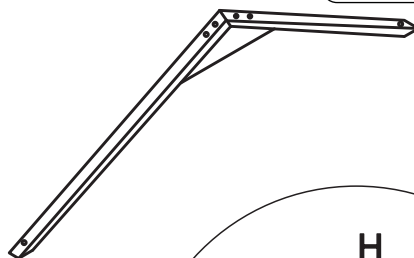

12



H	 Ø4,0x30mm BLACK	08
----------	--	-----------

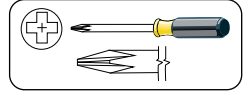

CAUTION!

Please be careful when assembling this product due the parts are extremely heavy. Also, please do not allow kids around when assembling this bed to avoid injuries!

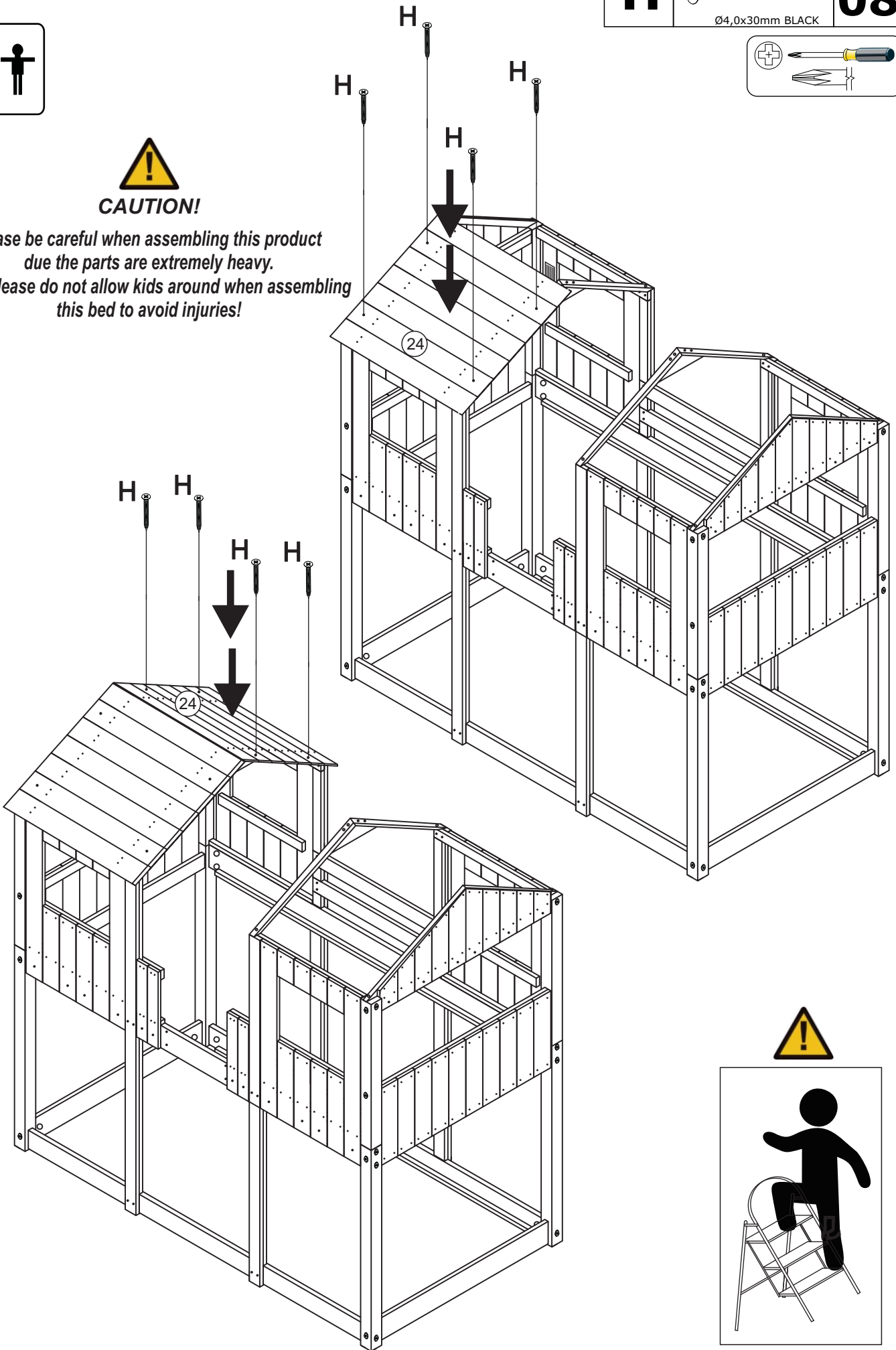

13



H	 Ø4,0x30mm BLACK	08
----------	--	-----------

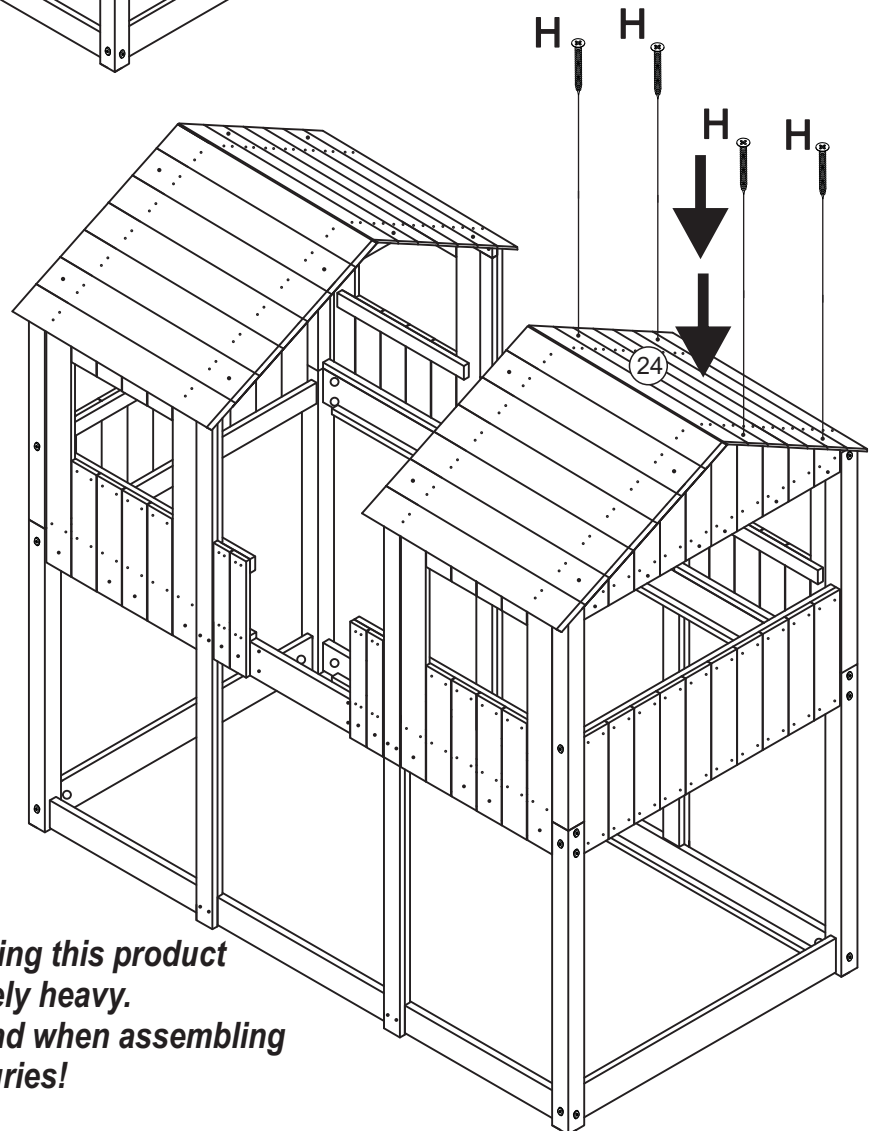
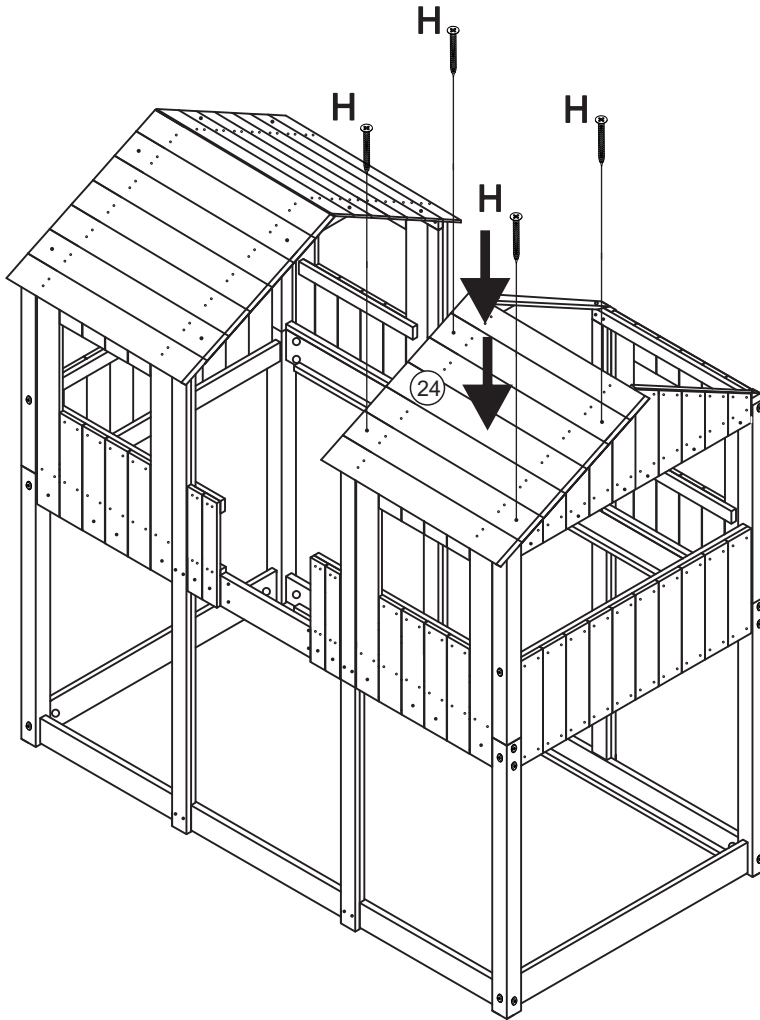
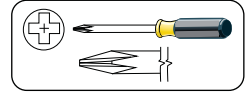

CAUTION!

Please be careful when assembling this product due the parts are extremely heavy. Also, please do not allow kids around when assembling this bed to avoid injuries!

14 LADDER

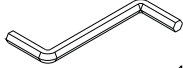
I	 Ø7x60mm - 17	06 G	 4mm	01
----------	---	-------------	---	-----------

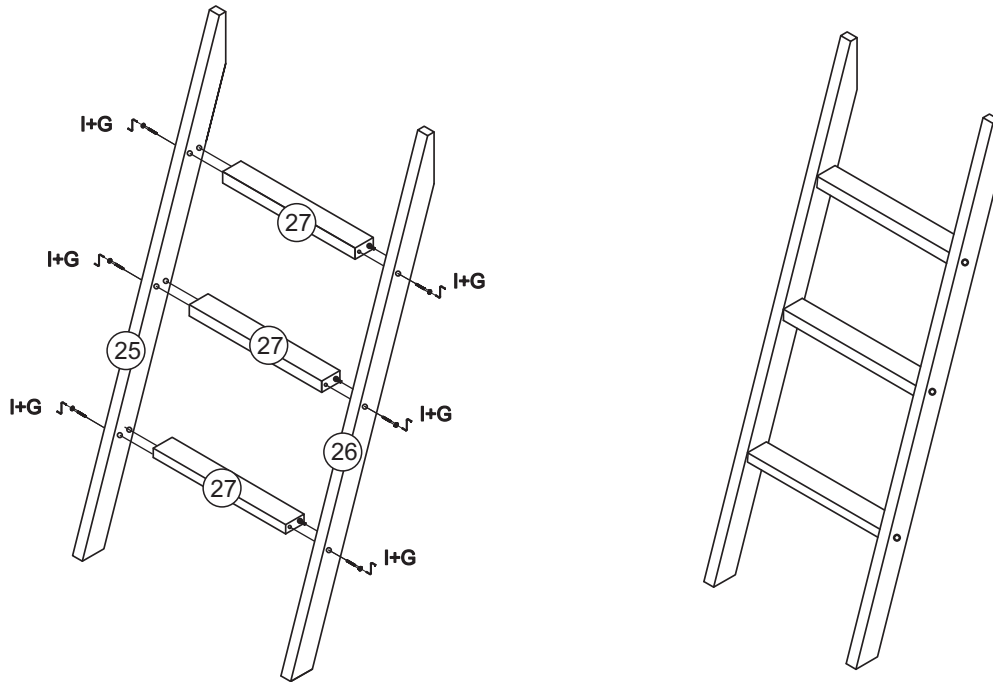

15

I	 Ø7x60mm - 17	04 G	 4mm	01
----------	---	-------------	--	-----------

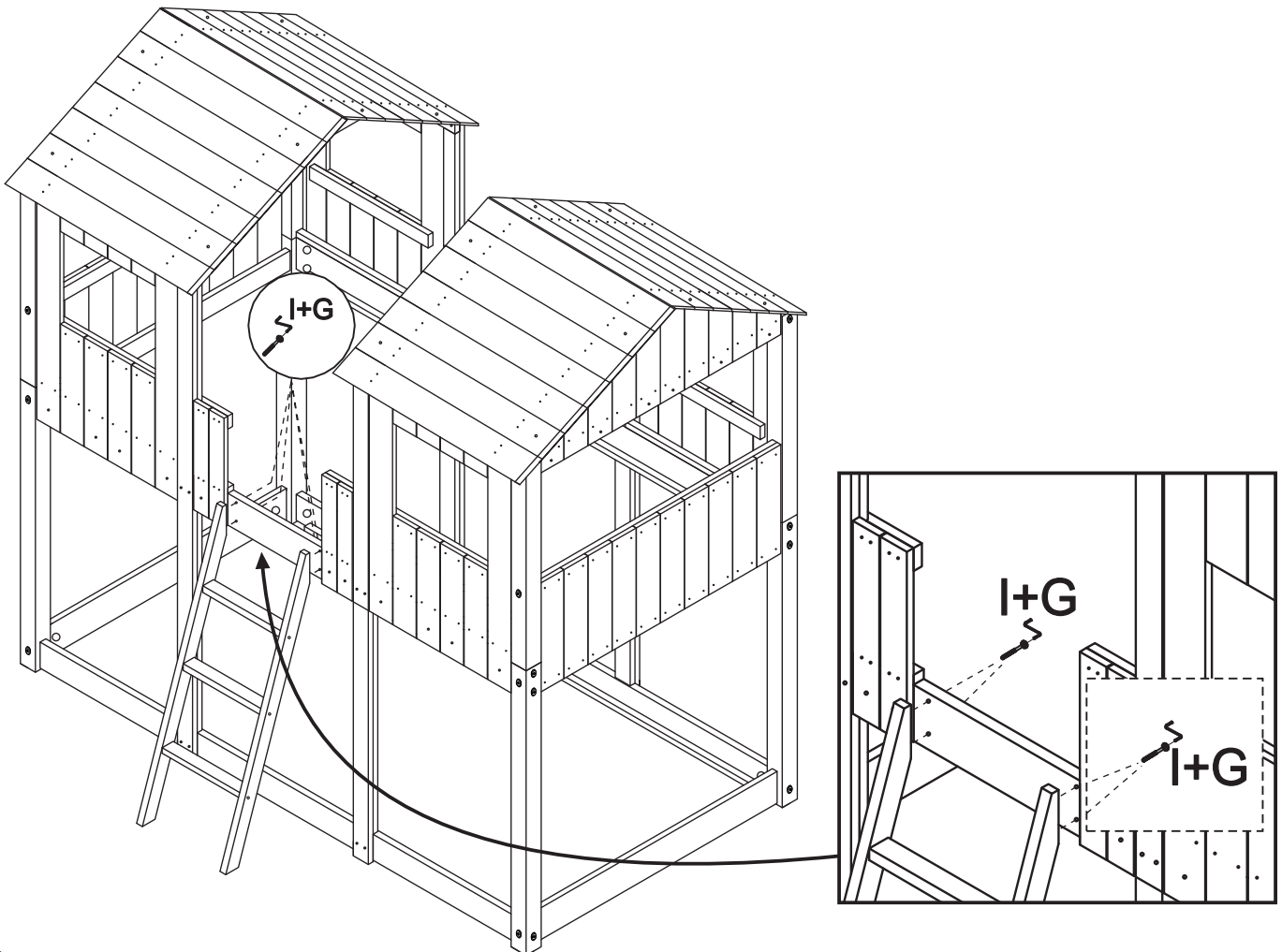

16

F

Ø3,5x30mm

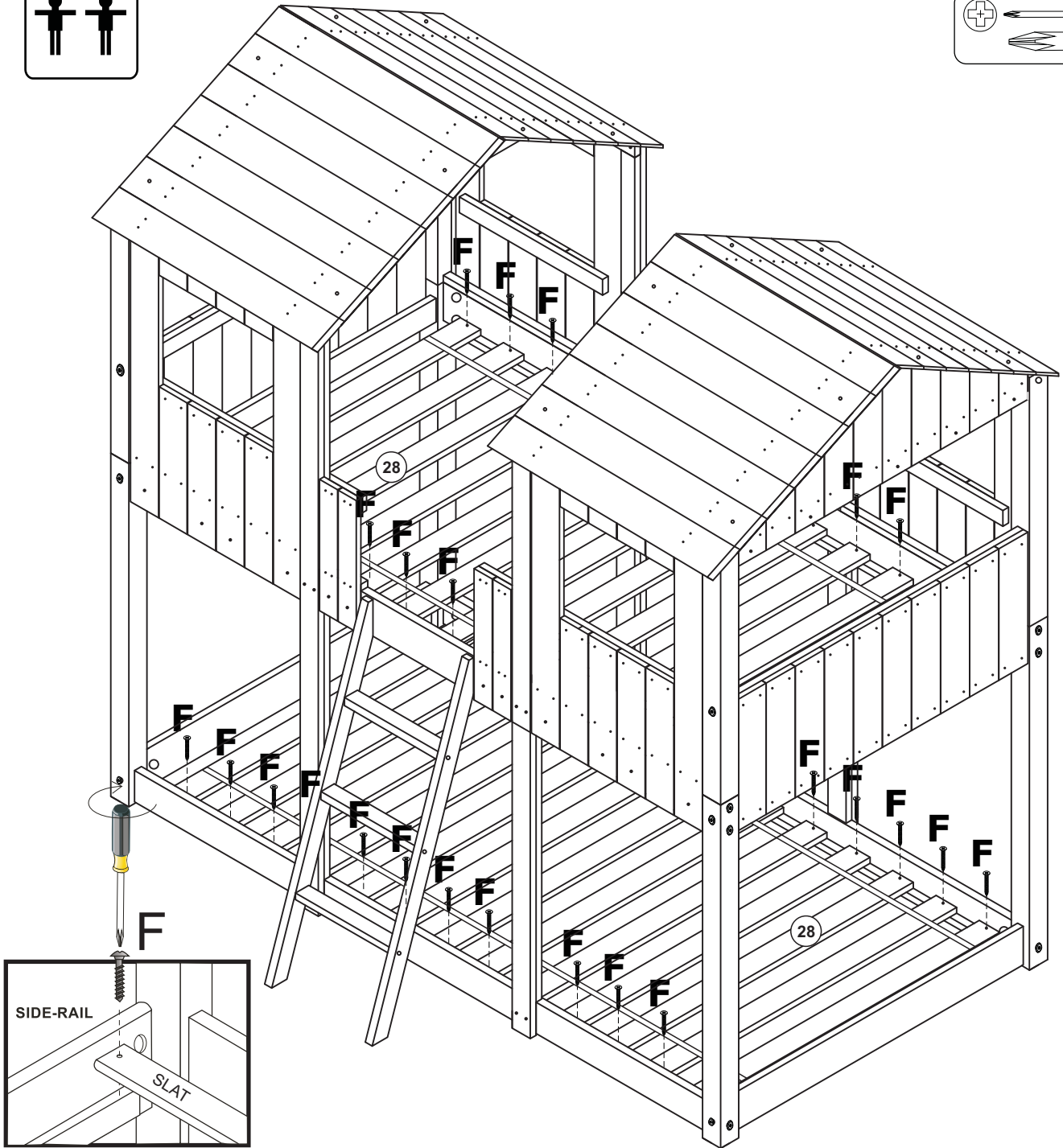
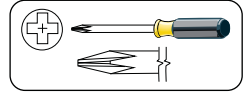
52

“INSTALL SLAT KIT WITH SPACER TAPE ON TOP (FACING UP)”



THE FIRST SLATS MUST BE FIXED AT 3" FROM EACH HEADBOARD END.

