







RTG Style # : AMGLFLPR/AMGLSNPR  
RTG SKU # : 38176029 / 38276021

Manufactured for Rooms To Go



TOOLS REQUIRED: NO TOOLS REQUIRED

PART LIST

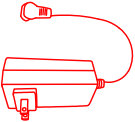
NO.	Description	Item	QTY
A	Back rest		1x
B	Seat		1x
C	Left wing		1x
D	Right wing		1x
E	Wall Plug		1x

List of Parts

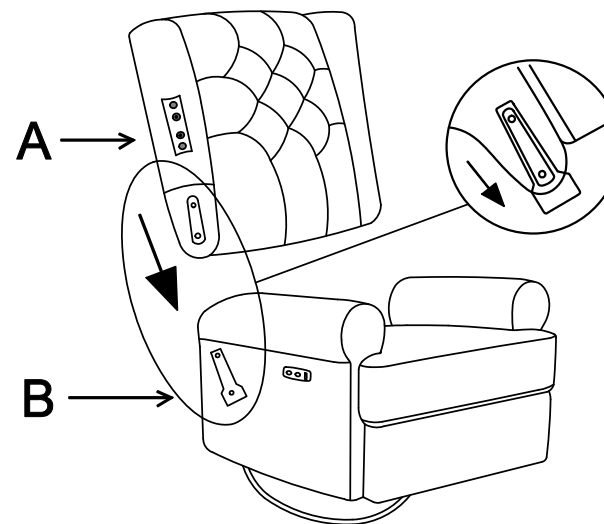
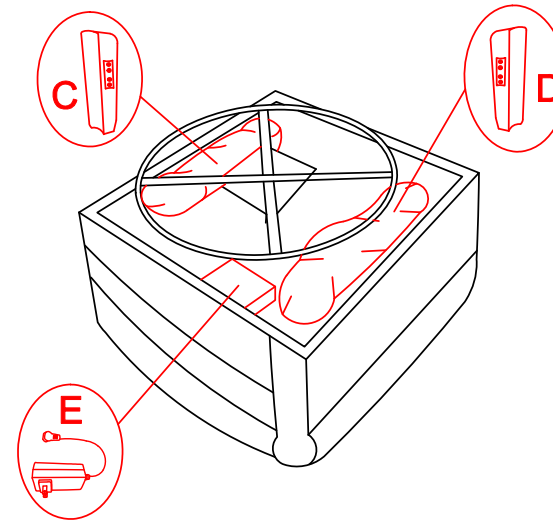

# ASSEMBLY INSTRUCTIONS

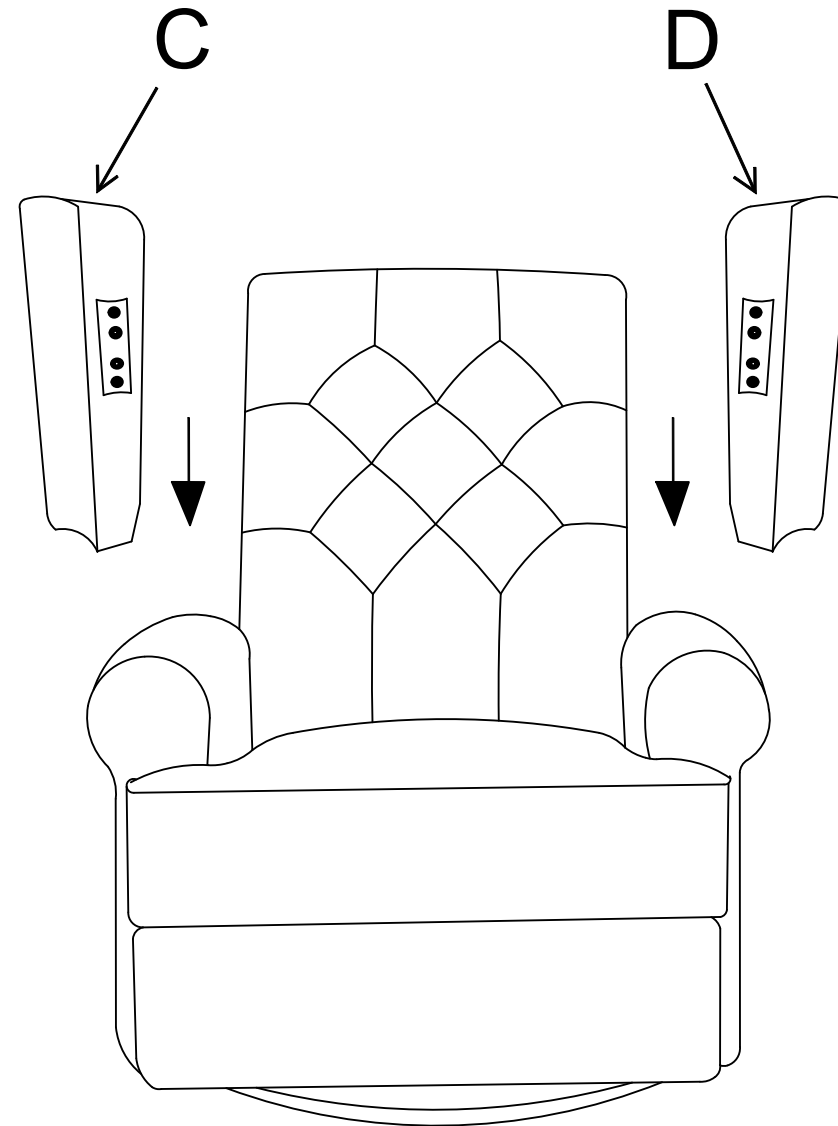

# ASSEMBLY INSTRUCTIONS

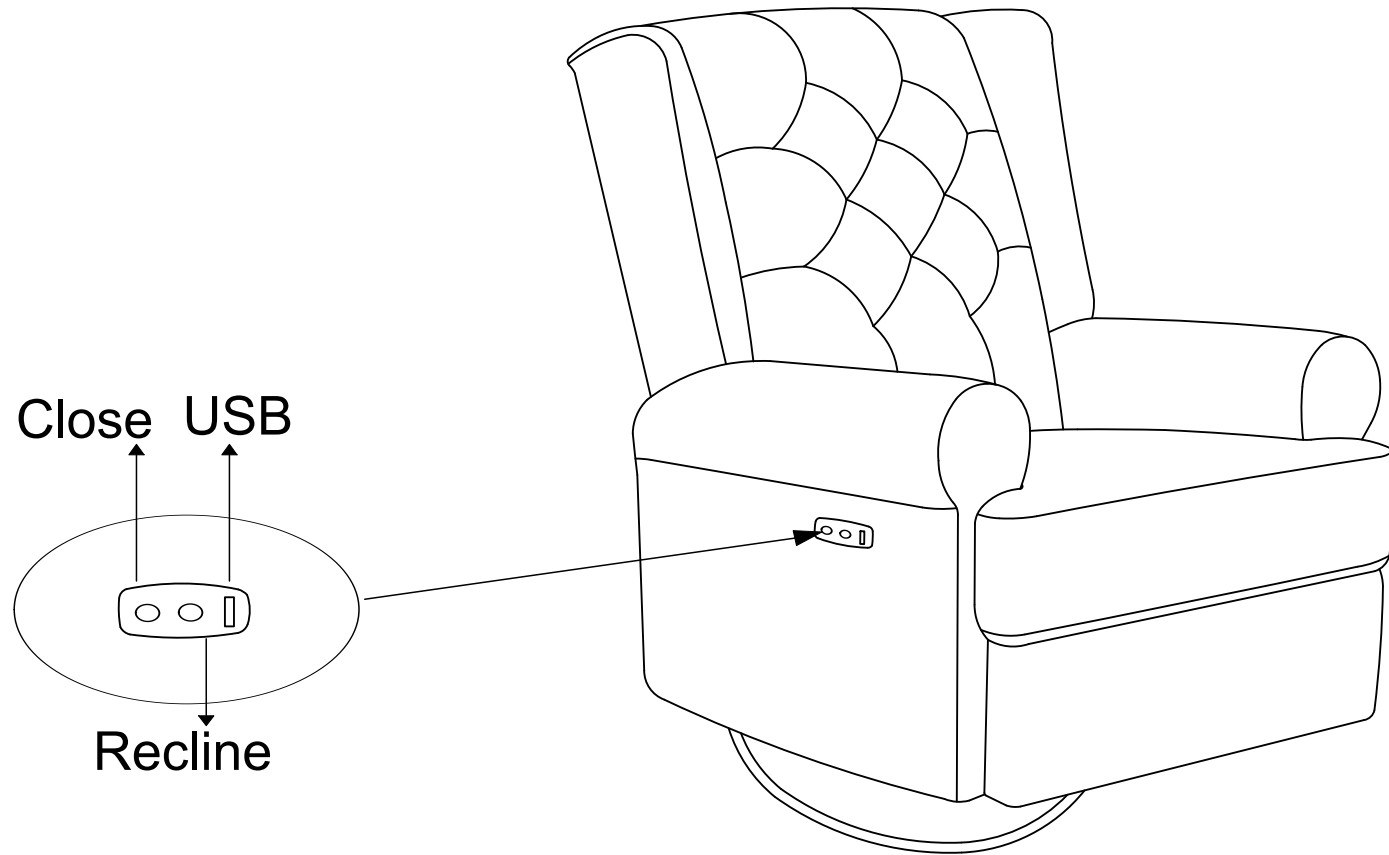

# POWER CONNECTIONS

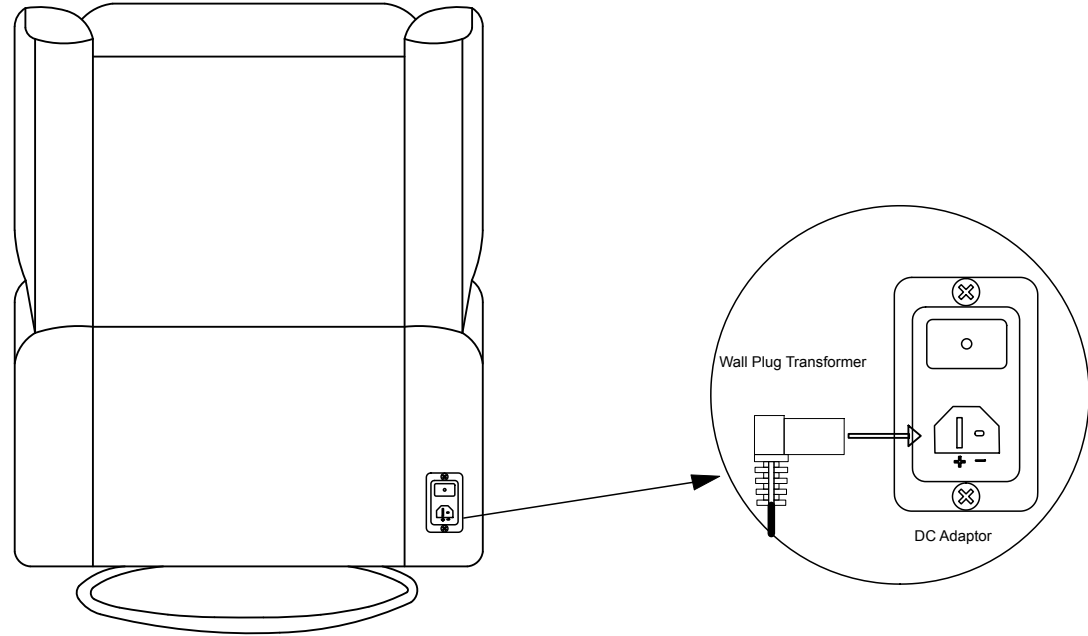
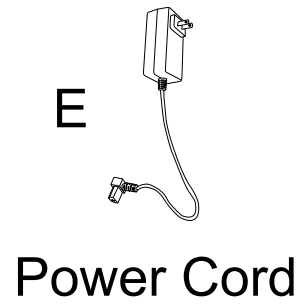

STEP 4: Connect power cord to transformer.

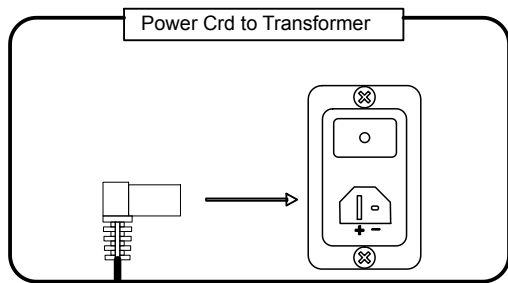

STEP 5: Connect wall Plug Transformer to outlet.

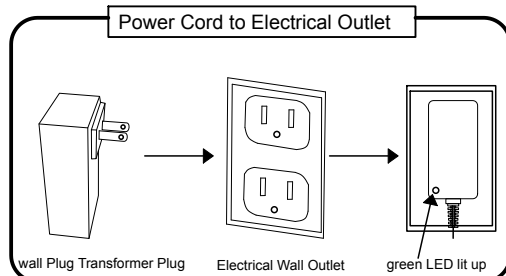

STEP 6: After all connections are made, the green LED will be lit up.

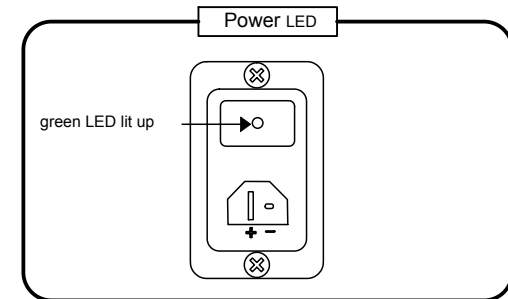

# POWER CONNECTIONS

ENGLISH

SPANISH

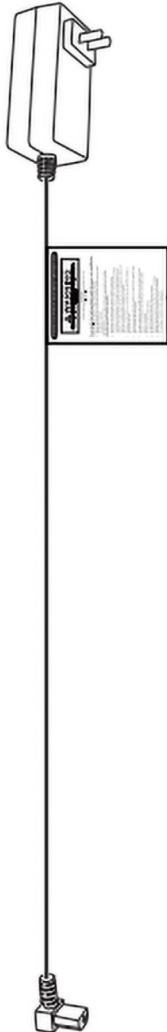

## **WARNING**

Misuse can result in **FIRE** or **DEATH** by **ELECTRICAL SHOCK**

29VDC/2A  
Changzhou Kaidi Electrical Inc.  
KDDY008M

**Read all instructions before using this furnishing.**

**DANGER – To reduce the risk of electric shock**

1. Always unplug this furnishing from the electrical outlet before cleaning or servicing.

**WARNING – To reduce the risk of burns, fire, electric shock, or injury to persons:**

1. Unplug from outlet before putting on or taking off parts.
2. Never operate this furnishing if it has a damaged electrical cord or plug, if it is not working properly, or if the electrical cord or plug has been damaged or dropped into water. Stop using this furnishing and call a service center for examination and repair.
3. Keep the electrical cord and plug away from heated surfaces and other heat sources.
4. To disconnect, turn all controls to the off position, then remove plug from outlet.
5. When operating, ensure that electrical cord is not under the base, legs, or motion mechanism to avoid damage to electrical cord or plug.
6. Do not strain or stretch electrical cord.
7. Do not use extension cords or power strips.
8. Keep out of reach of children. This is not a toy.
9. Plug directly into a compatible electrical socket.
10. Do not modify the plug or use any adapters.

## **WARNING**

El mal uso puede provocar **INCENDIO** o **MUERTE** por **DESCARGA ELÉCTRICA**

29VDC/2A  
Changzhou Kaidi Electrical Inc.  
KDDY008M

**Leer todas las instrucciones antes de usar este mobiliario.**

**PELIGRO – Para reducir el riesgo de descarga eléctrica:**

1. Siempre desenchufe este accesorio de la toma de corriente eléctrica antes de limpiarlo o repararlo.

**ADVERTENCIA: para reducir el riesgo de quemaduras, incendios, descargas eléctricas o lesiones a personas:**

1. Desenchufe del tomacorriente antes de colocar o quitar partes.
2. Nunca opere este accesorio si tiene un cable o enchufe eléctrico dañado, si no funciona correctamente, o si el cable o el enchufe eléctrico se ha dañado o se ha caído al agua. Deje de usar este equipamiento y llame a un centro de servicio para que lo examinen y lo reparen.
3. Mantenga el cable eléctrico y el enchufe lejos de superficies calientes y otras fuentes de calor.
4. Para desconectar, gire todos los controles a la posición de apagado, luego retire el enchufe del tomacorriente.
5. Al operar, asegúrese de que el cable eléctrico no esté debajo de la base, las patas o el mecanismo de movimiento para evitar dañar el cable eléctrico o el enchufe.
6. No fuerce ni estire el cable eléctrico.
7. No utilizar cables de extensión o tomas de corriente.
8. Mantener fuera del alcance de los niños. Esto no es un juguete.
9. Enchúfelo directamente a una toma de corriente compatible.
10. No modifique el enchufe ni utilice adaptadores.

# WARNINGS

- \*Keep unit at least 24" from all heat sources.
- \*Avoid placing unit in areas where unit can be exposed to direct sunlight or other powerful light sources, as fading or discoloration may occur.
- \*Maintain minimum of 6" space between the furniture backs and wall.

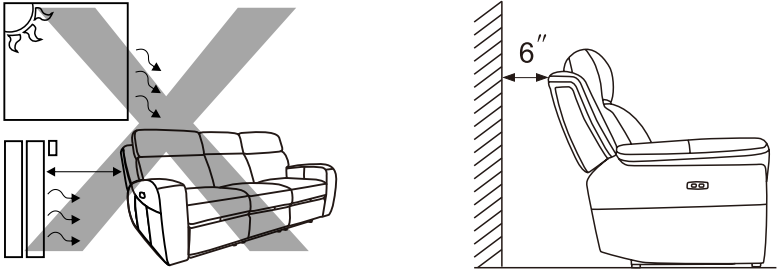

- \*Do not leave when the recliner is not fully closed.
- \*Do not reach under seat when mechanism is operating or serious injury may occur.
- \*Reclining mechanism should only be operated while seated properly.

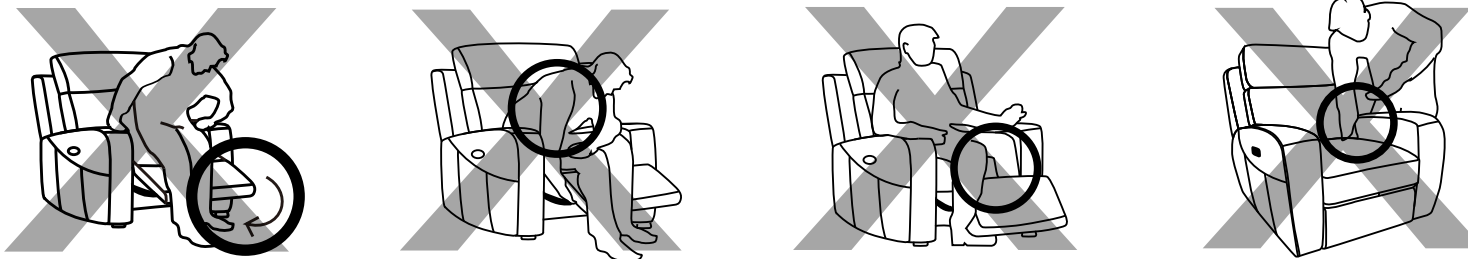

- \*Do not sit on arms or backrest.
- \*Do not jump or roughhouse on furniture.
- \*Do not sit on the footrest when mechanism is open.

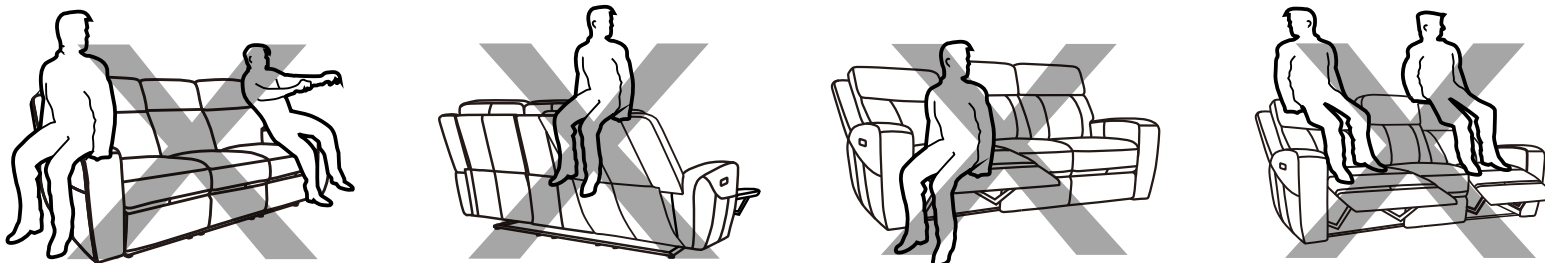

\*If unit must be moved, do not drag. Unit must be lifted in order to be moved.

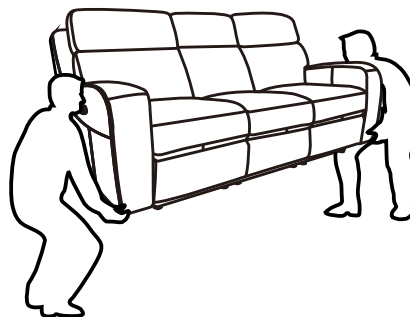
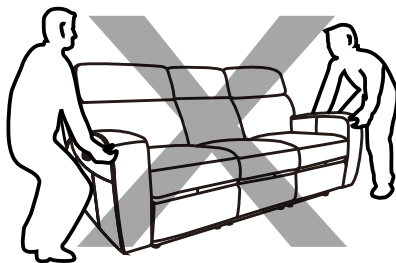
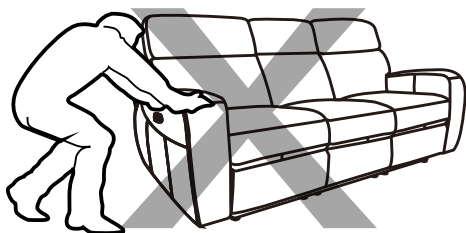

\*Do not continuously operate mechanism for more than one minute or unit may go into protection mode by shutting down to prevent overheating.

\*Unplug unit from power source prior to cleaning mechanism.

\*Do not allow electrical components to come into contact with any liquids.

## CARE AND CLEANING

\*Upholstered furniture is packaged tightly to protect it during transit. This packaging can sometimes cause creases or misshaped cushions when the furniture comes out of the packaging. These issues will correct themselves over time as the fibers of the cushions are exposed to air. However, shaping the cushions with your hands can alleviate the creases and compressed fibers more quickly.



Before shaping



After shaping



\*Dust often and use a vacuum cleaner to remove debris from seams and crevasses.

\*Use a soft damp cloth to gently clean soiled areas and wipe clean. Do not rub.

\*Do not use household cleaners or solvents. Such cleaners may cause damage and/or discoloration.

\*Do regularly use dedicated leather care product onto the leather furniture to prevent built up of body oils.



# TROUBLE SHOOTING

PROBLEM	SOLUTION
Not Reclining	Ensure that wall power outlet is operational Step 4,5,6
USB not working	Check all power connections Step 4,5,6