

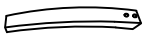

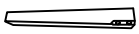



# ASSEMBLY INSTRUCTION

## PARTS IDENTIFICATION/ LISTE DE MATERIÉL

| No | Drawing   | Description            | Qty |
|----|---|------------------------|-----|
| 1  |  | SEAT CUSHION/COUSSIN   | 1   |
| 2  |  | BACK LEG/JAMBE ARRIÈRE | 2   |
| 3  |  | FORNT LEG /AVANT       | 2   |
| B  |  | silver ring            | 1   |

## HARDWARE LIST/ LISTE DE MATERIÉL

| No | Drawing  | Description           | Qty |
|----|--|-----------------------|-----|
| A  |  | 5mm                   | 1   |
| B  |  | $\phi 5/16 * 2''$     | 4   |
| E  |  | $\phi 5/16 * 1-3/4''$ | 4   |
| C  |  | $\phi 5/16$           | 8   |
| D  |  | $\phi 5/16$           | 8   |

## Complete assembly

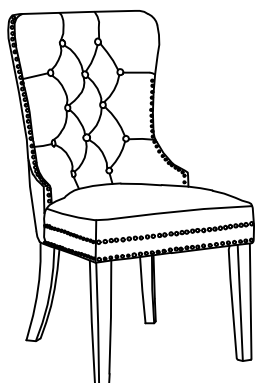

## STEP 2

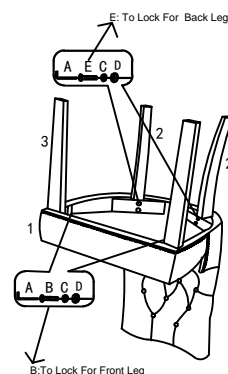

## STEP 1

Legs and hardware package are put inside the bottom of the chair.  
Les pattes et les pieces de montage se trouvent sous le siege de la chaise.

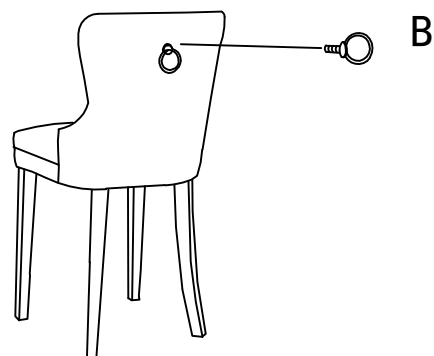
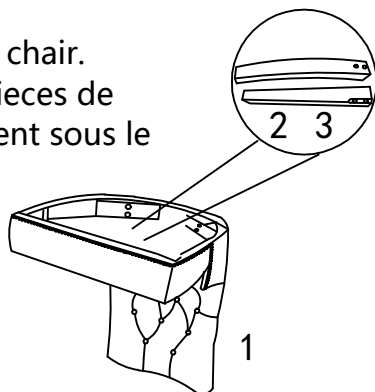

Finaly :Take the B (silver ring )put the backrest side