

Assembly Instructions

Item No. 53435

Thank you for purchasing this quality product. Be sure to check all packing material carefully for small parts that may have come loose inside the carton during shipment. (Note: Loosely thread all screws/bolts first. Once the item is assembled then completely tighten.)

PARTS LIST:				HARDWARE LIST:				
NO	Description	Sketch	Quantity	NO	Sketch	Description	Size	Quantity
A	Top		1	C		Bolt	Ø5/16" *1 1/2"	21
				D		flat washer	Ø5/16" *1/2"	21
B	Leg		2	E		lock washer	Ø5/16" *3/4"	21
				F		allen wrench		1

STEP: 1

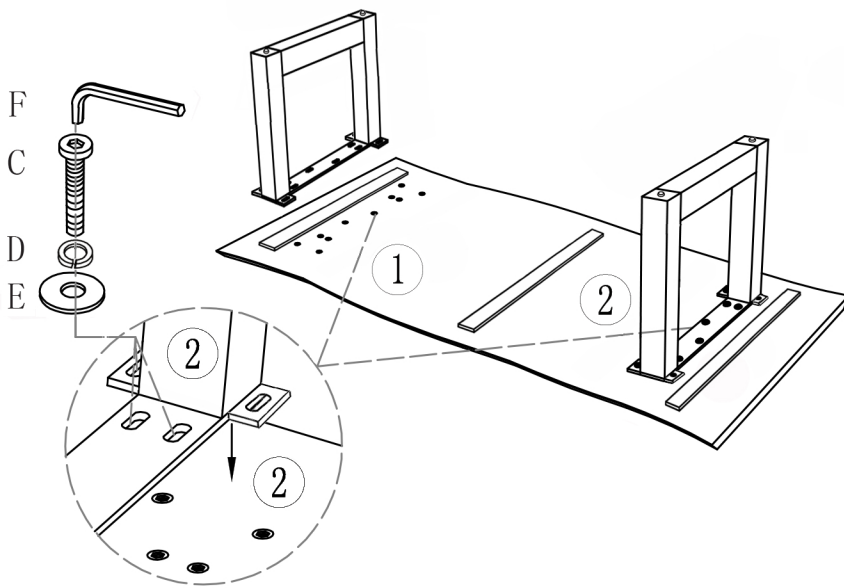

FINISH:

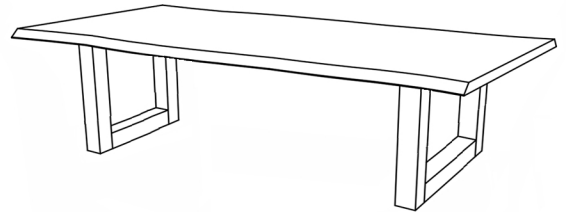

Tip for Leveling of product:

When the product rests on an uneven floor surface it will appear to be unbalanced. To aid in leveling, try adjusting the levelers on the bottom of each foot.

ADJUSTABLE LEVELERS

