

CLARION WOOD SWIVEL STOOL

Model # 103669-110723 (4541-826) Counter Stool / Model # 103669-110724 (4541-830) Bar Stool - Distressed Gray / Fog
 Model # 103669-110778 (4542-826C) Counter Stool / Model # 103669-110779 (4542-830) Bar Stool - Sea White / Fog







Date: 15-10-2017
 Page 1 of 1

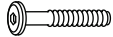

CONWAY WOOD SWIVEL STOOL

Model # 103669-110742 (4541-826L) Counter Stool - Distressed Gray / Ecu
 Model # 103669-110737 (4542-826) Counter Stool - Sea White / Ecu

Examine all packaging material for small parts that may have come loose during shipment. Periodic checks are recommended to insure that all components are in proper position, tight and free from damage. Keep this assembly instruction for future reference. Adult assembly is required. The product of Hillsdale Furniture, LLC is designed for residential use only. Customer Service Phone Number: 502-562-0000

HDFKC

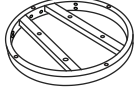
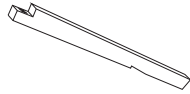
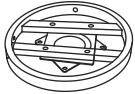
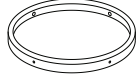
CODE	QTY	HARDWARE
A	14	M6-1.0 x 40mm Bolts 
B	4	M6-1.0 x 30mm Bolts 
C	18	M6 x 13mm Spring Washers 
D	14	M6 x 19mm Flat Washers 
E	4	Wood Screws 32mm 
F	1	Allen Wrench 

CODE	QTY	COMPONENTS	CODE	QTY	COMPONENTS
K	1	Stool Back 	L	1	Seat Base 
M	4	Legs 	N	1	Top Support Ring 
O	1	Bottom Support Ring 	P	1	Cushion Seat 

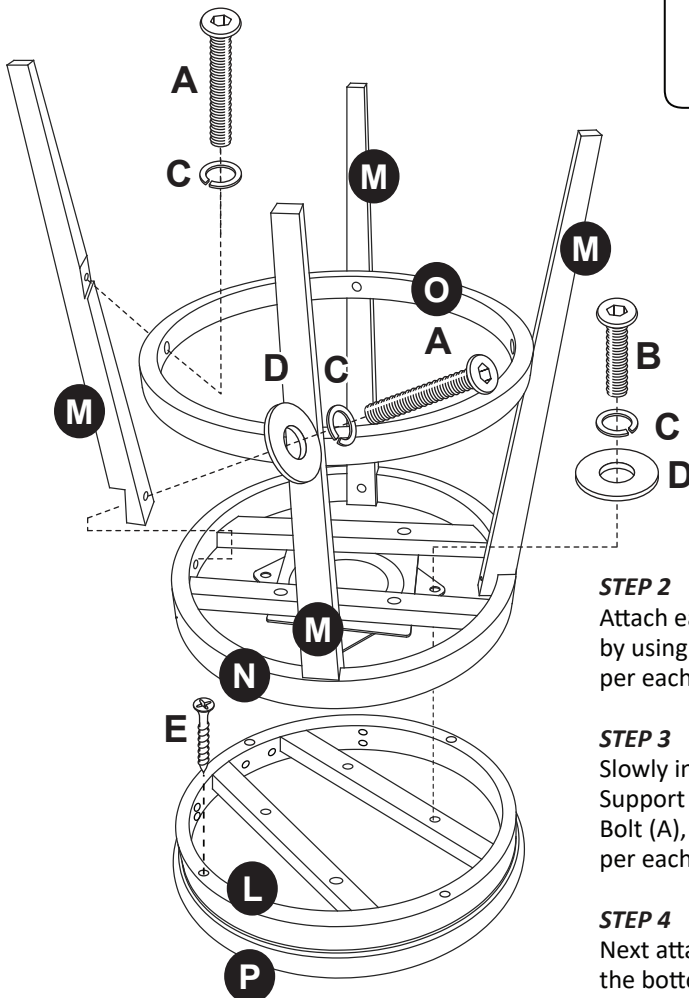

STEP 1

Begin the assembly by attaching the Seat Base (L) to the Stool Back (K). Once in place, secure each arm of the Stool Back (K) using 3 Allen Bolts (A), 3 Spring Washers (C) & 3 Flat Washers (D) per side. Tighten all bolts using the Allen Wrench (F).

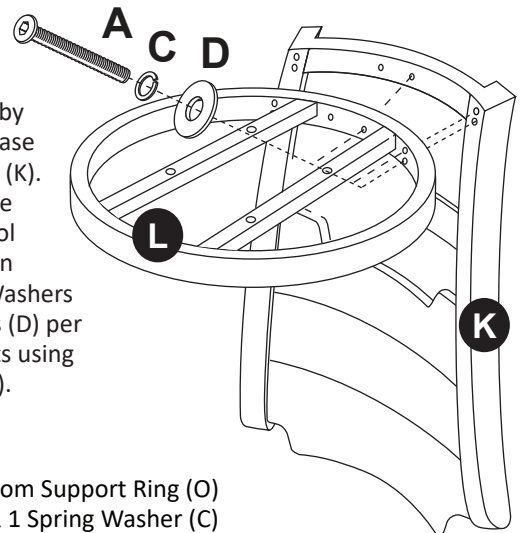

STEP 2

Attach each Leg (M) to the Bottom Support Ring (O) by using 1 Long Allen Bolt (A) & 1 Spring Washer (C) per each Leg. Do not fully tighten bolts.

STEP 3

Slowly insert the assembled leg base into Top Support Ring (N) in place by using 1 Long Allen Bolt (A), 1 Spring Washer (C) & 1 Flat Washer (D) per each Leg. Tighten all bolts using Allen Wrench (F).

STEP 4

Next attach the pre-assembled Swivel Metal Plate to the bottom of Seat Base (L) using 4 short Allen Bolts (B), 4 Spring Washers (C) & 4 Flat Washers (D) to secure in place from the bottom. Tighten all bolts.

STEP 5

Last, attach the Seat Cushion (P) to the Seat Base (L) by securing with 1 Wood Screw (E) per hole. Tighten all screws using a Philips head screwdriver (not included). The assembly is now complete.

