



















***Caution: Please read all instruction carefully before starting the assembly process. These parts are cumbersome and heavy. Therefore, two people are recommended in order to prevent personal injury and ensure the parts are not damaged during the assembly.

Code	Parts List		
A	TABLE TOP		1 PC
B	LEG		2 PCS
C	LOWER STRETCHER		1 PC
D	UPPER STRETCHER		2 PCS

Step	Code	Hardware List		
1	#1	Bolt - Ø5/16" X 18 X 1-1/2"		6 PCS
	#3	Lock Washer - Ø5/16"		6 PCS
	#4	Flat Washer - Ø5/16" X 3/4"		6 PCS
2	#2	Bolt - Ø5/16" X 18 X 2"		2 PCS
	#3	Lock Washer - Ø5/16"		2 PCS
	#4	Flat Washer - Ø5/16" X 3/4"		2 PCS
3	#2	Bolt - Ø5/16" X 18 X 2"		1 PC
	#3	Lock Washer - Ø5/16"		1 PC
	#4	Flat Washer - Ø5/16" X 3/4"		1 PC
4	#1	Bolt - Ø5/16" X 18 X 1-1/2"		6 PCS
	#2	Bolt - Ø5/16" X 18 X 2"		3 PCS
	#3	Lock Washer - Ø5/16"		9 PCS
	#4	Flat Washer - Ø5/16" X 3/4"		9 PCS
1+2+3+4	#5	Open Wrench - Ø5/16"		1 PC

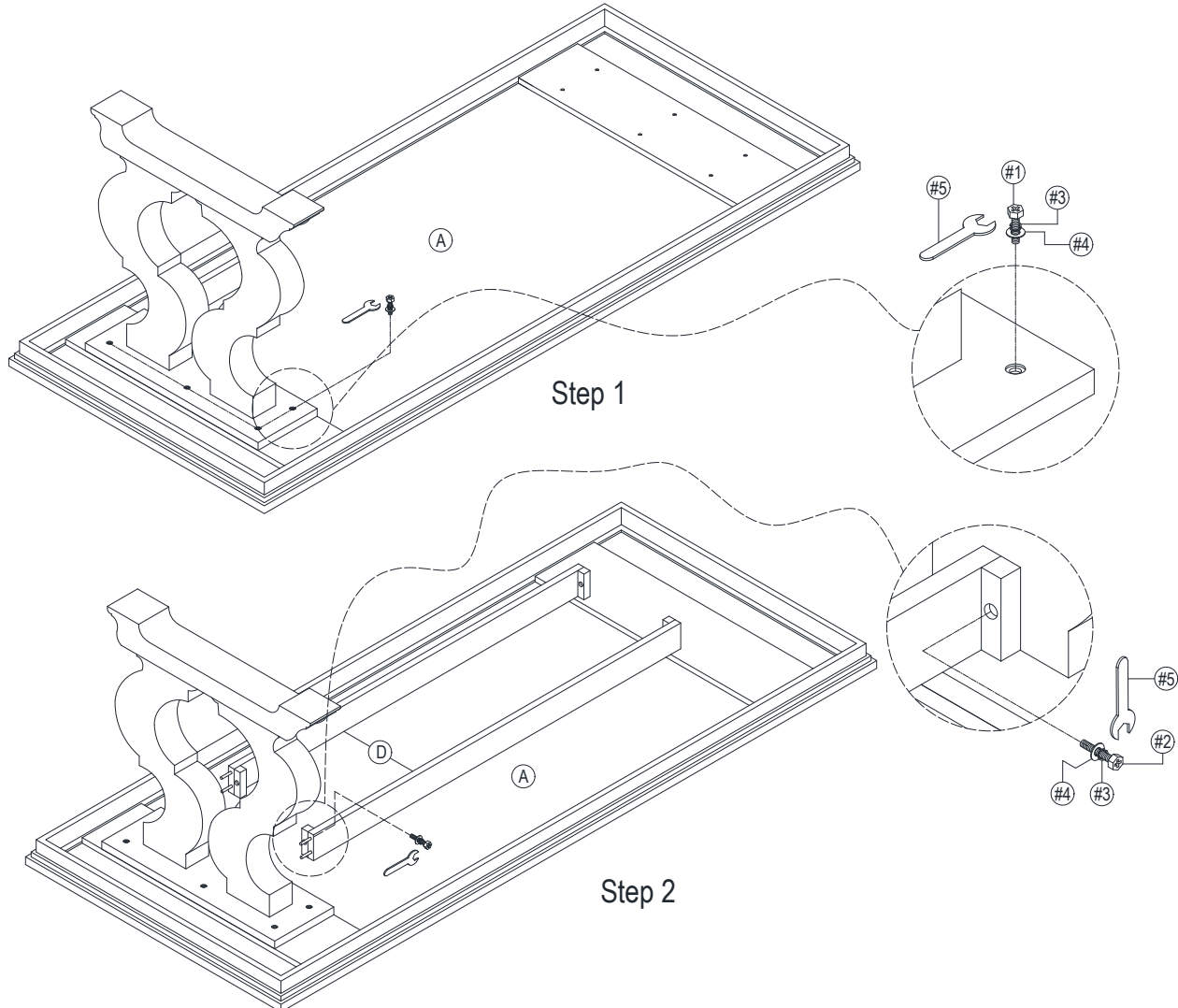

***Caution: Please read all instruction carefully before starting the assembly process. These parts are cumbersome and heavy. Therefore, two people are recommended in order to prevent personal injury and ensure the parts are not damaged during the assembly.

