

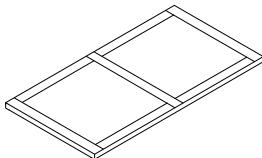



HOUS 6592-TT/6596TT TRESTLE TBL TOP
6592-TB/6596TB TRESTLE TBL BS

SKU# 42265923/42265961
SKU# 42365925/42365963

WARNING: To avoid alignment issue, please don't tighten the screws unless all legs are adjusted at the same level.

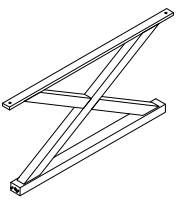
HARDWARE LIST / LISTE DE QUINCAILLERIE			QTY' / QTÉ	PART LIST / LISTE DE PIÈCES			QTY' / QTÉ
A	Long Bolt Ø5/16"x18x2"		12pcs	1	Table Top Dessus de table		1 PC 1 Pièce
	Boulon Ø5/16"x18x2"		12pièces				
B	Spring Washer Ø5/16x14x2mm		12pcs				
	Rondelle de ressort Ø5/16x14x2mm		12pièces				
C	Flat Washer Ø5/16x16x2mm		12pcs	2	Stretcher Barreau		1 PC 1 Pièce
	Rondelle plate Ø5/16x16x2mm		12pièces				
D	Allen Key 75*25*4mm		1 pc				
	Clé Allen 75*25*4mm		1 pièces				
E	Wooden pegs Ø8x30mm		4 pc				
	Chevilles en bois Ø8x30mm		4 pièces				

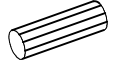
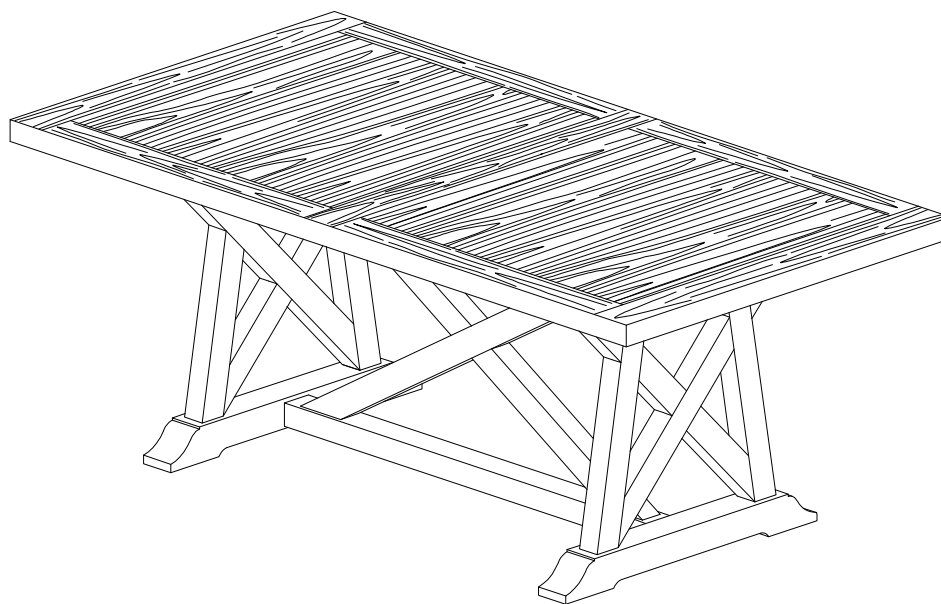

ASSEMBLY COMPLETED / ASSEMBLÉE TERMINÉE

HOUS 6592-TT/6596TT TRESTLE TBL TOP
6592-TB/6596TB TRESTLE TBL BS

SKU# 42265923/42265961
SKU# 42365925/42365963

*****Caution: Please read all instructions carefully before starting the assembly process. These parts are cumbersome and heavy. Therefore, two people are recommended in order to prevent personal injury and ensure the parts are not damaged during the assembly.**

*****Avertissement: veuillez lire toutes les instructions attentivement avant de commencer l'assemblage. Ces pièces sont encombrantes et lourdes. Il est recommandé d'être deux personnes pour l'assemblage afin de prévenir des blessures et/ou risquer d'endommager les pièces.**

**STEP 1
ÉTAPE 1**

Attach the stretcher to table base

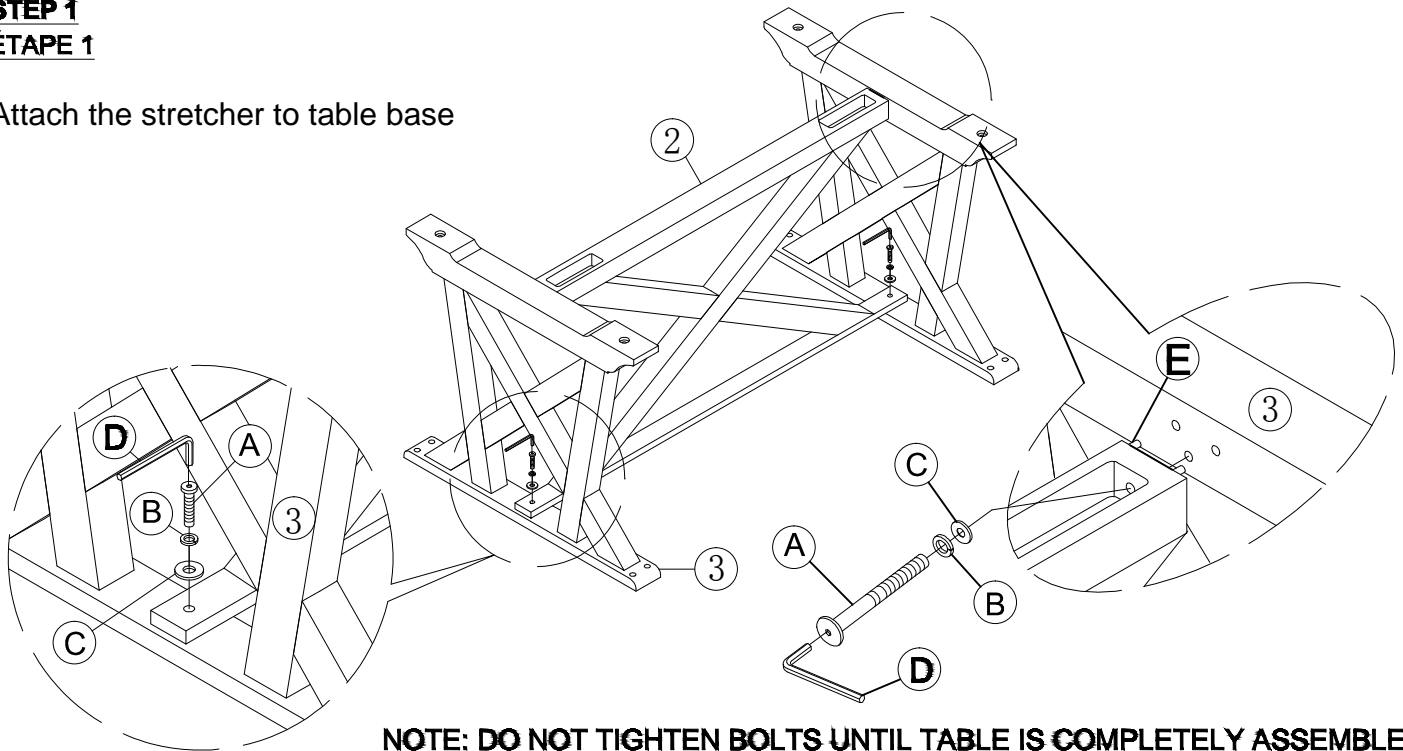

NOTE: DO NOT TIGHTEN BOLTS UNTIL TABLE IS COMPLETELY ASSEMBLED.

**STEP 2
ÉTAPE 2**

Attach table base to table top

