







***Caution: Please read all instructions carefully before starting the assembly process. These parts are cumbersome and heavy. Therefore, two people are recommended in order to prevent personal injury and ensure the parts are not damaged during the assembly.

Code	Parts List		
1	Table Top		1Pc
2	Leaves		2Pcs
3	Legs		4Pcs

Step	Code	Hardware List		
1	A	Flat washer - Ø5/16x19x1.5mm		8Pcs
	B	Lock washer - Ø5/16"		8Pcs
	C	Nut - Ø5/16"		8Pcs
	D	Wrench - Ø5/16"		1Pc

TOOLS REQUIRED (NOT PROVIDED)

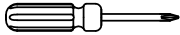
Description	Sketch
Phillips screwdriver	

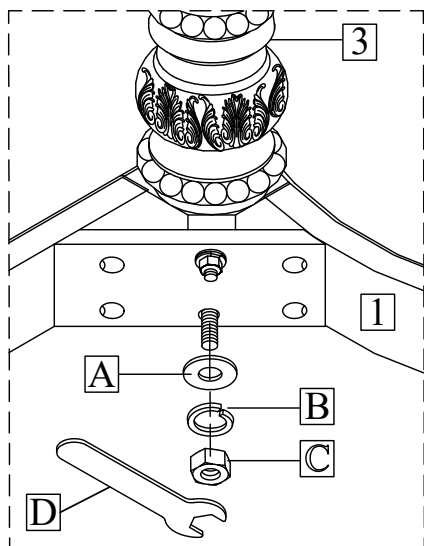
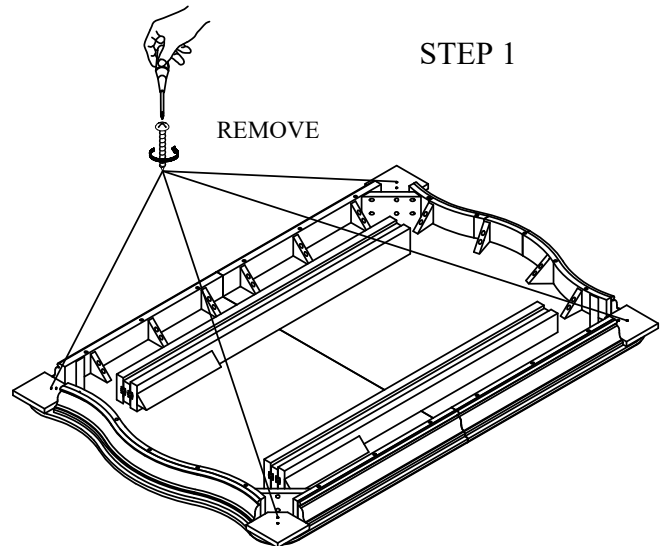
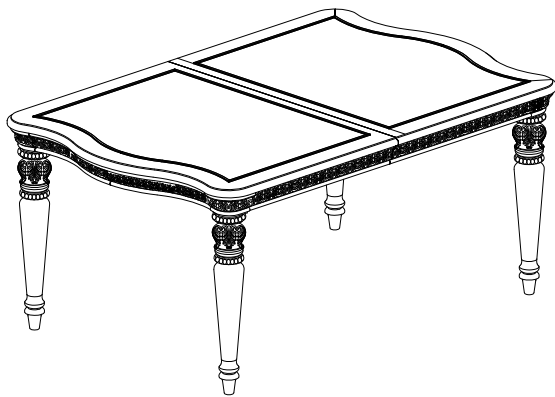

STEP 2

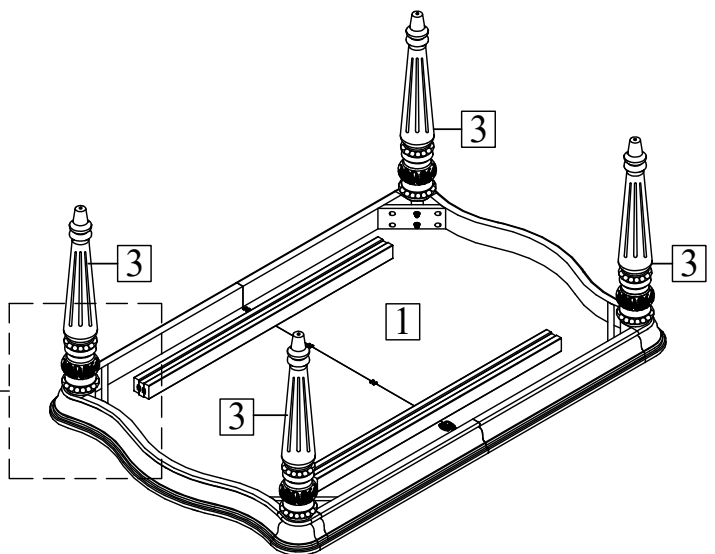

***Caution: Please read all instructions carefully before starting the assembly process. These parts are cumbersome and heavy. Therefore, two people are recommended in order to prevent personal injury and ensure the parts are not damaged during the assembly.

STEP 3

