





Assembly Instructions

PULA 3363-270 UPH Side Chair - SKU# 42433639





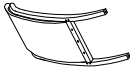





Manufactured by PULA for Rooms To Go

***** Caution : Please read all instructions carefully before starting the assembly process. These parts are cumbersome and heavy. Therefore, two people are recommended in order to prevent personal injury and insure the parts are not damaged during the assemble.**

PARTS LIST

No.	Description	Sketch	Q'ty
1	Chair Seat		1 Pc
2	Chair Back		1 Pc
3	Front Leg (Left & Right)		2 Pcs
4	Bottom Stretcher		2 Pcs

HARDWARE LIST

No.	Description	Size	Sketch	Q'ty
A	Allen Bolt	Ø5/16 " x 18 x3"		4 Pcs
B	Allen Bolt	Ø1/4 " x20 x1-9/16"		2 Pcs
C	Lock Washer	Ø1/4 "		2 Pcs
D	Flat Washer	Ø1/4 " x 3/4"		2 Pcs
E	Allen Key Z	M4		1 Pc
F	Hexagon Nut	Ø5/16 "		4 Pcs
G	Lock Washer	Ø5/16 "		8 Pcs
H	Flat Washer	Ø5/16 " x 3/4"		8 Pcs
I	Spanner Wrench	12mm		1 Pc
K	PH Screw	M4 x 1-3/4"		4 Pcs

STEP 1: Flip the chair seat (1) upside down. Place a blanket or some form of padding underneath of the top of placing on a hard surface to avoid scratches. Place front leg (3) so that it fits the predetermined pin holes in back panel of chair seat. Use the Spanner Wrench (I) to tighten Flat Washer (H), Lock Washer (G) & Hexagon Nut (F).

TOOLS REQUIRED (NOT PROVIDED)

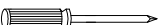
Description	Sketch
Phillips screwdriver	

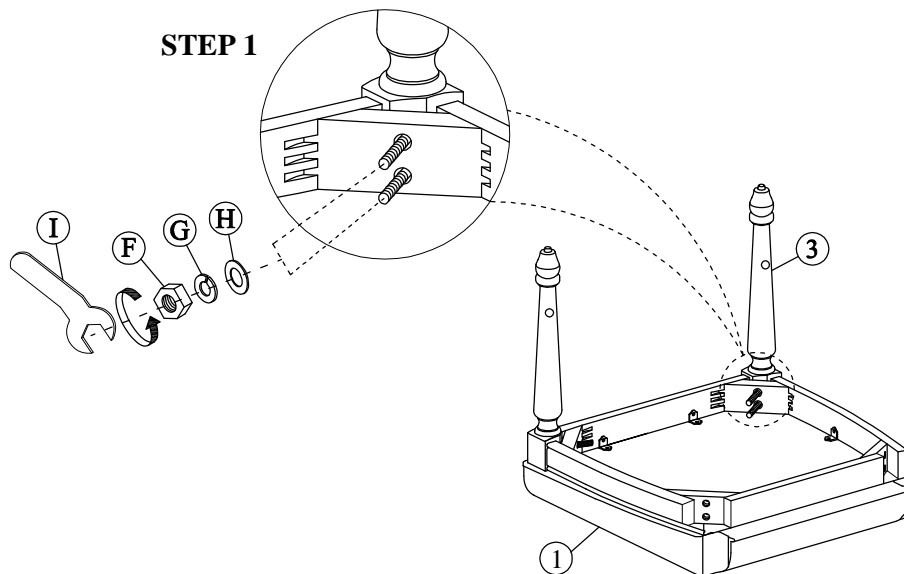

Hardware Pack Location (s): Bolts pack at UPH Side Chair

Uph Side Chair SKU# 42433639



Assembly Instructions

PULA 3363-270 UPH Side Chair - SKU# 42433639

Manufactured by PULA for Rooms To Go

***** Caution : Please read all instructions carefully before starting the assembly process. These parts are cumbersome and heavy. Therefore, two people are recommended in order to prevent personal injury and insure the parts are not damaged during the assemble.**

STEP 2: Flip the chair back (2) upside down. Place a blanket or some form of padding underneath of the top of placing on a hard surface to avoid scratches. Place chair seat (1) so that it fits the predetermined pin holes in back panel of chair seat. Use the Allen key Z (E) to tighten Flat Washer (H), Lock Washer (G) & Allen Bolt (A).

STEP 3: Use the Allen key Z (E) to tighten Flat Washer (D), Lock Washer (C) & Allen Bolt (B).

STEP 4: Position the stretcher to fit the predetermined peg holes on the back of the front & back legs. Use a screwdriver to tighten the screws (screwdriver not provided).

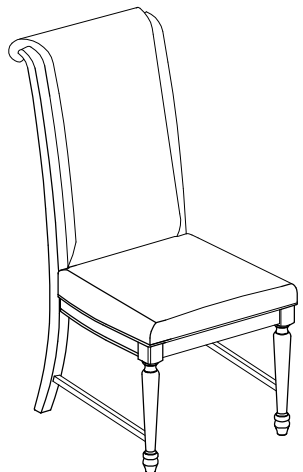
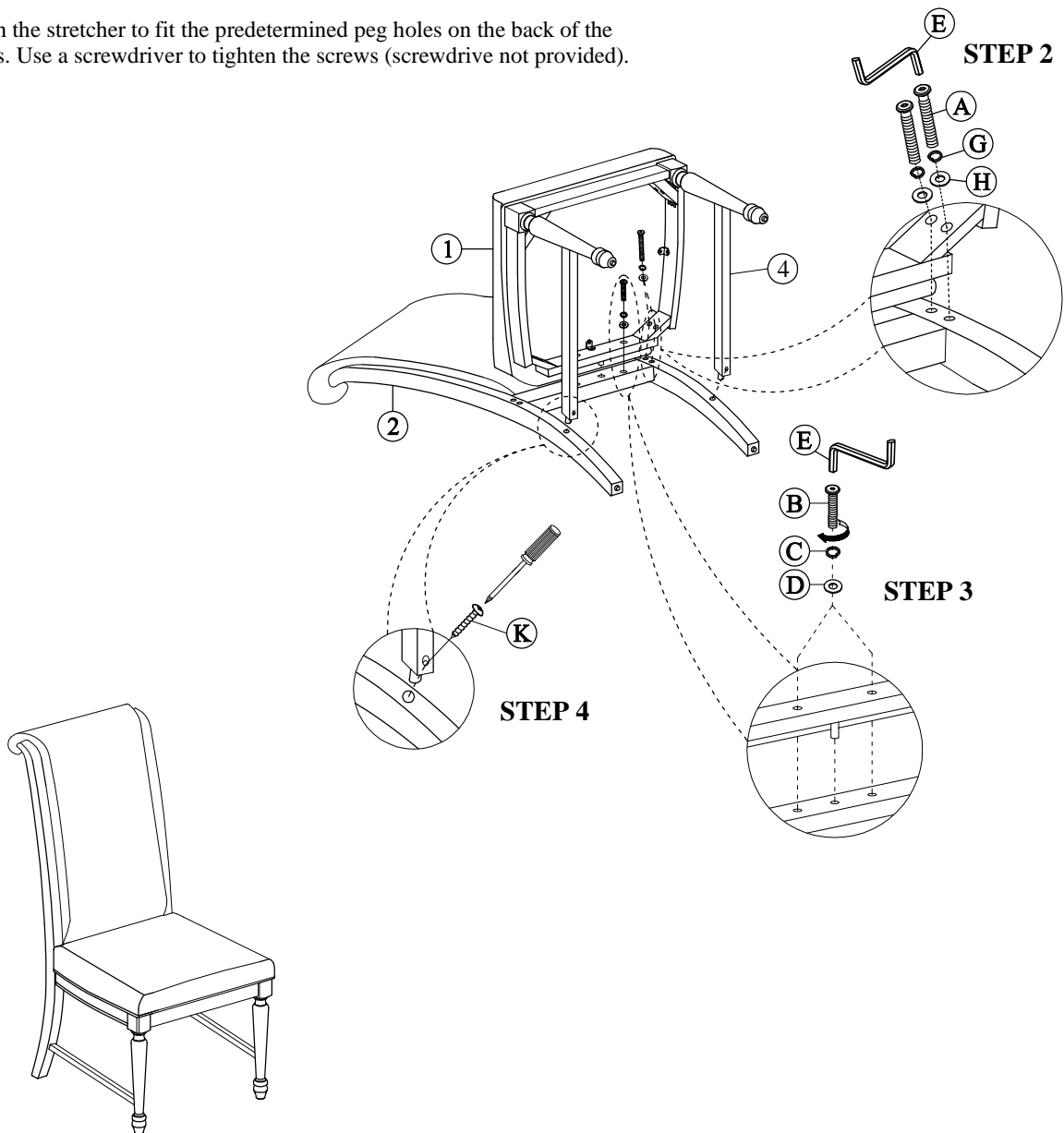

COMPLETE ASSEMBLY

Hardware Pack Location (s): Bolts pack at UPH Side Chair

Uph Side Chair SKU# 42433639