

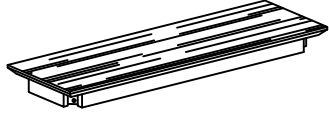





Assembly Instruction Instructions d'assemblage

HOUS 1173-313-BEN DINING BENCH, DARK
1183-313-BEN DINING BENCH, LIGHT OAK

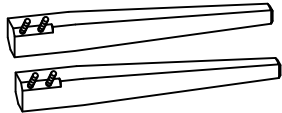
SKU# 42511736
SKU# 42511837

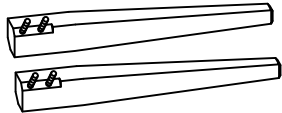
WARNING: To avoid alignment issue, please don't tighten the screws unless all legs are adjusted at the same level.

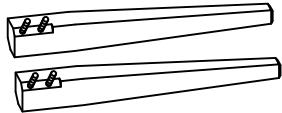
HARDWARE LIST / LISTE DE QUINCAILLERIE			QTY' / QTÉ	PART LIST/LISTE DE PIÈCES			QTY' / QTÉ
A	Hex-Nut Ø5/16"		8 pcs 8 pièces	1	SEAT SIEGE		1 PC 1 PIÈCE
	Ecrou Hexagonal Ø5/16"						
B	Spring Washer Ø5/16" x Ø1/2" x 1/16"		8 pcs 8 pièces	2	FRONT LEG PIEDS AVANT		4 PCS 4 PIÈCES
	Rondelle de ressort Ø5/16" x Ø1/2" x 1/16"						
C	Flat Washer Ø5/16" x Ø3/4" x 1/16"		8 pcs 8 pièces	2	FRONT LEG PIEDS AVANT		4 PCS 4 PIÈCES
	Rondelle plate Ø5/16" x Ø3/4" x 1/16"						
D	Wrench 3-1/2" x 1/2"		1 pc 1 pièce	2	FRONT LEG PIEDS AVANT		4 PCS 4 PIÈCES
	Clé 3-1/2" x 1/2"						

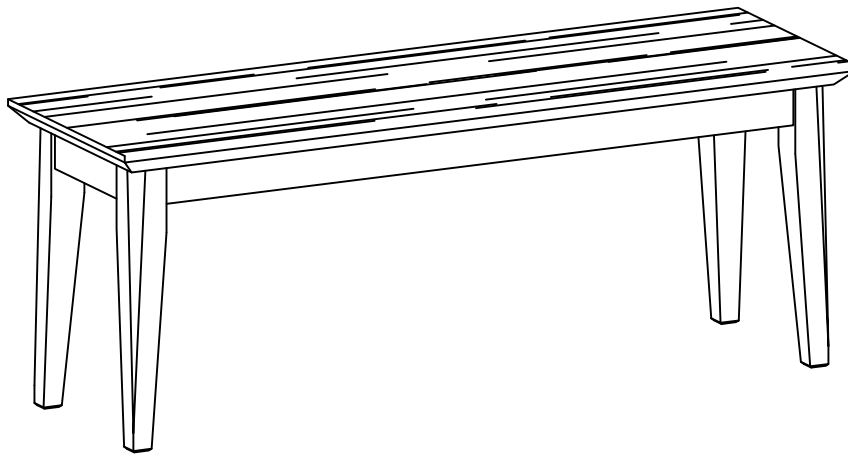

ASSEMBLY COMPLETED

Hardware Pack Location(s):

1173-313-BEN DINING BENCH, DARK SKU# 42511736
1183-313-BEN DINING BENCH, LIGHT OAK SKU# 42511837

HOUS 1173-313-BEN DINING BENCH, DARK
1183-313-BEN DINING BENCH, LIGHT OAK

SKU# 42511736
SKU# 42511837

***Caution: Please read all instructions carefully before starting the assembly process. These parts are cumbersome and heavy. Therefore, two people are recommended in order to prevent personal injury and insure the parts are not damaged during the assembly.

***Avertissement: veuillez lire toutes les instructions attentivement avant de commencer l'assemblage. Ces pièces sont encombrantes et lourdes. Il est recommandé d'être deux personnes pour l'assemblage afin de prévenir des blessures et/ou risquer d'endommager les pièces.

STEP 1

ÉTAPE 1

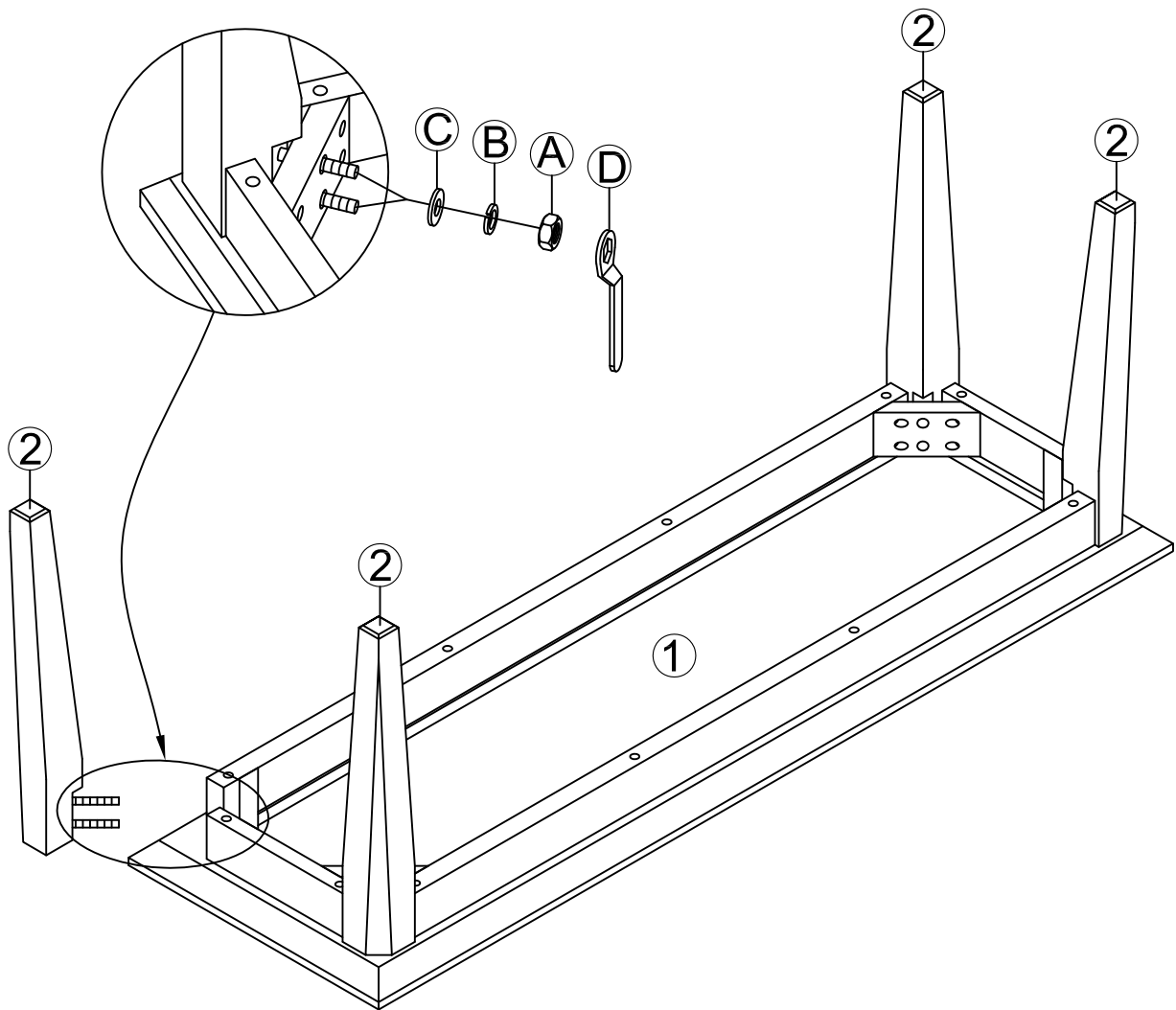

Attach the front legs to the seat frame.

Note: Do not tighten all bolts until the seat is fully assembly