

ASSEMBLY INSTRUCTION

EMRI 2582-64 SKU # 42525824
 EMRI 2582-66 SKU # 42525836
 EMRI 2581-69 SKU # 42525812
DINING BENCH

Thank you for purchasing this product. Be sure to check all packing materials carefully for small parts that may have come loose inside the carton during shipment.

Before You Assemble: Please read all instructions carefully before beginning assembly. It is recommended that 2 people work together during assembly to prevent personal injury and to ensure that heavy or cumbersome parts are not damaged during the process.



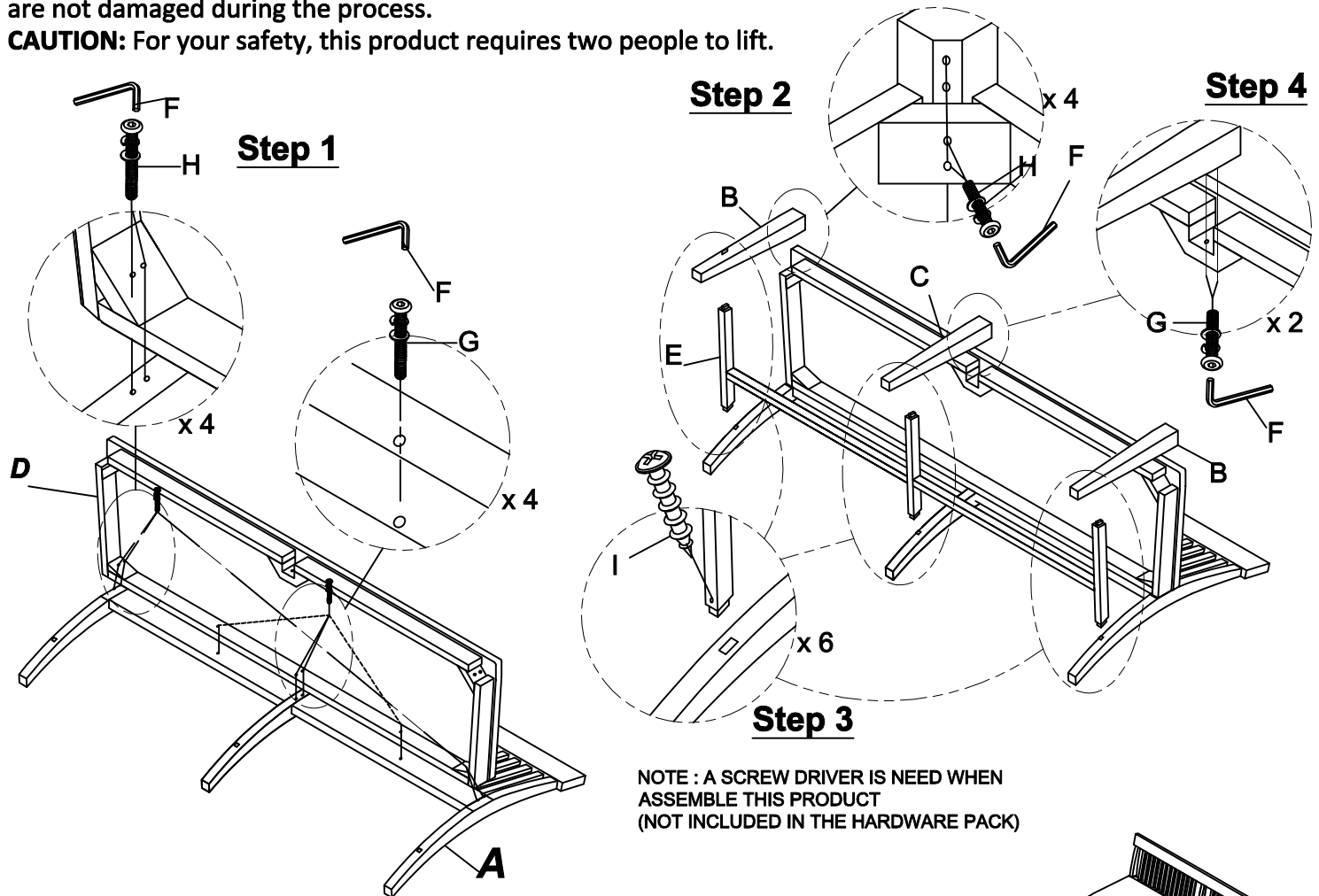



CAUTION: For your safety, this product requires two people to lift.

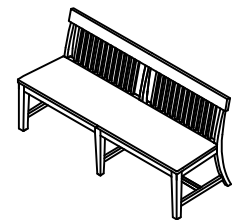

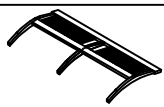
NOTE : A SCREW DRIVER IS NEED WHEN ASSEMBLE THIS PRODUCT (NOT INCLUDED IN THE HARDWARE PACK)

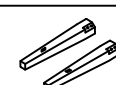
NOTE : WAIT TO TIGHTEN ALL COMPONENTS COMPLETELY UNTIL UNIT IS FULLY ASSEMBLED. THIS WILL ALLOW FOR EASIER ASSEMBLY.

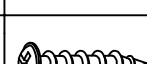
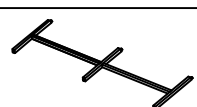

PICTURE	DESCRIPTION	Q'TY	PICTURE	DESCRIPTION	Q'TY
A 	BACK CHAIR EHF # N/A	1pc	F 	ALLEN KEY 20*60*4mm EHF # HDWR	1pc
B 	LEGS L / R EHF # LEGS L/R	2pcs	G 	BOLT 5/16" *18* 1 3/4" EHF # HDWR	6pcs
C 	CENTER LEG EHF # CTRLEG	1pc	H 	BOLT 5/16" *18* 3 1/4" EHF # HDWR	8pcs
D 	SEAT EHF # N/A	1pc	I 	SCREWS 4 X 1 1/2" EHF # HDWR	6pcs
E 	CENTER CROSS RAIL EHF # CR STR	1set			