









# Assembly Instructions

## SSIO VD480BNG-R Vida Dining Bench

Manufactured by SSIO for Rooms To Go

SKU:42558037

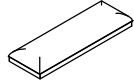
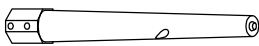
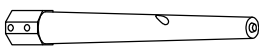
Step	Code	Hardware	Qty
	A	ALLEN KEY 	1PC
1	B	BOLT 5/16"x18x2" 	8PCS
1	C	LOCK WASHER 5/16"x13mm 	8PCS
1	D	FLAT WASHER 5/16"x19mm 	8PCS
1	E	SCREW #8x1-1/2" 	4PCS

Part Number	Picture	Description	Material	Qty
PVD480BNG-RSC		Seat Cushion	Foam+Rubber Wood	1PC
PVD480BNG-RFL		Front Leg	Rubber Wood	2PCS
PVD480BNG-RBL		Back Leg	Rubber Wood	2PCS
PVD480BNG-RST		Stretcher	Rubber Wood	2PCS
PVD480BNG-RLEV		Leveler	Plastic+Iron	4PCS

Hardware Pack Location(s): Underneath of the seat

Vida Dining Bench  
04/18/2024

SKU:42558037



# Assembly Instructions

## SSIO VD480BNG-R Vida Dining Bench

SKU:42558037

\*\*\*Caution. Please read all instructions carefully before starting the assembly process. These parts are cumbersome and heavy. Therefore, two people are recommended in order to prevent personal injury and ensure the parts are not damaged during the assembly.

### STEP 1

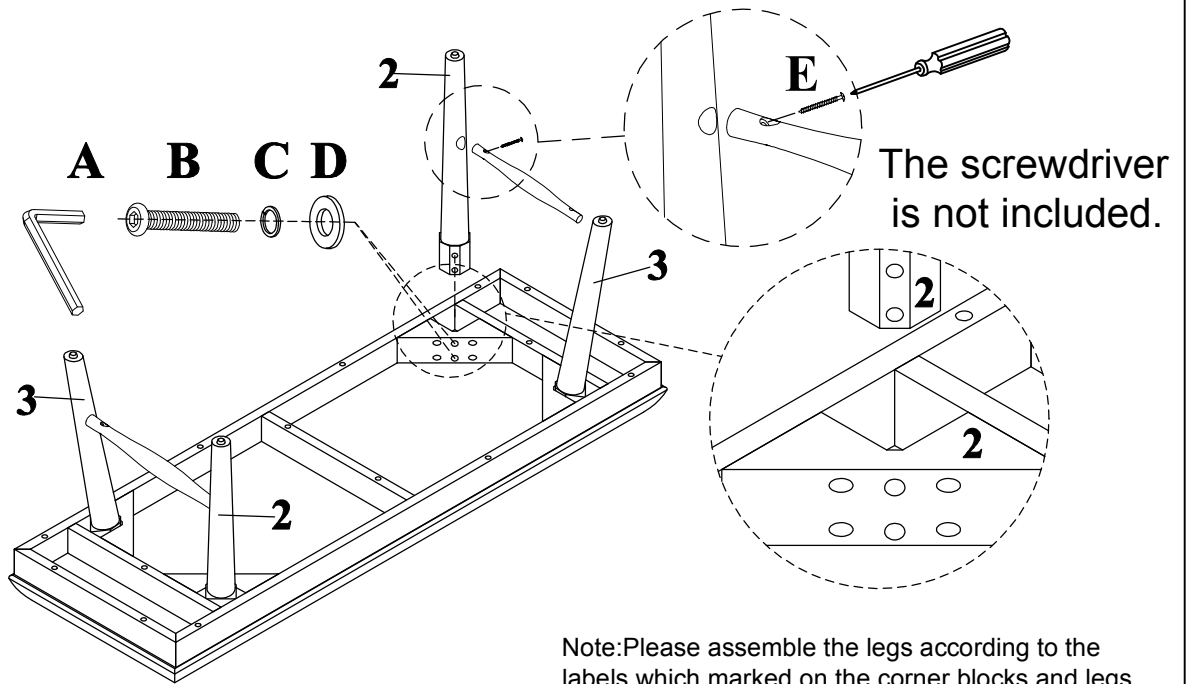

Attach the legs to the seat frame.

Note: Do not tighten all screws & bolts until the seat is fully assembly.

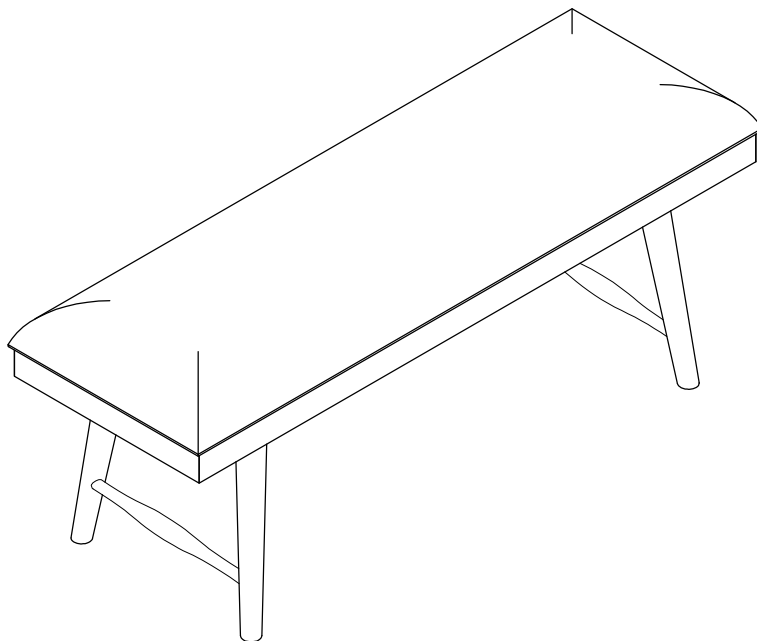

Stand **bench** up on an even surface and check that it is balanced. If there is a slight wobble, apply downward pressure in the corner where a leg is uneven. Keeping pressure in that corner, tighten all bolts. If balanced, apply downward pressure evenly in the center and tighten all bolts.