



Assembly Instructions



Item#: 282/273-312
S272/S273-312

Description: Server

42702820

Thank you for purchasing this quality product. Be sure to check all packing materials carefully for small parts that may come loose inside the carton during shipment.

Parts List			
No.	Drawing	Description	Qty
A		Server	1pc
B		Caster	4pcs

Hardware List				
No.	Drawing	Description	Size	Qty
C		Allen Bolt with Washers	$\varnothing 1 \frac{5}{8}''$	16pcs
D		Umbrella head Bolt	$\varnothing 1 \frac{3}{4}''$	2pcs
E		Allen Wrench	$\varnothing 1''$	1pc

Step 1

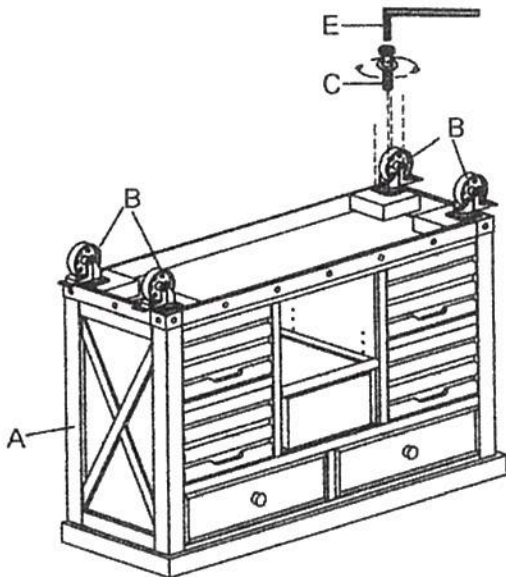

Step 2

COVER THE TWO HOLES WITH BOLTS IF THIS CASE IS NOT USED WITH THE HUTCH.



TAKE OUT EPS FILLER

Step 3

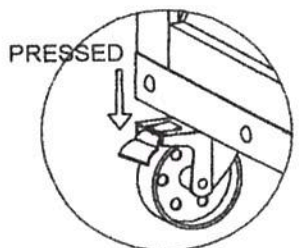

PRESS BRAKE TO STOP

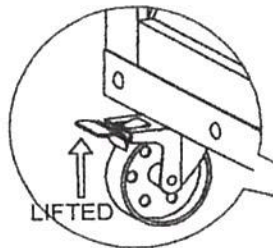

LIFT BRAKE TO MOVE

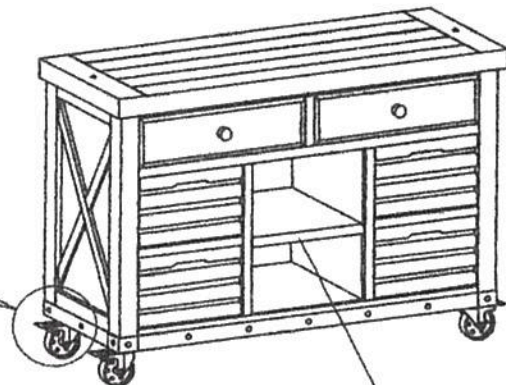

WINE SHELF IS REVERSIBLE