



Manufactured by LEGC for ROOMS TO GO





# ASSEMBLY INSTRUCTIONS





## LEGC 5413-570 DISPLAY CABINET - SKU: 42854136

Version 1: 05.09.2025

**Caution:** Please read the instructions thoroughly before unpacking and assembly. Sharp, exposed staple tips can cause injury. Therefore, for your protection, please remove any exposed staples used in the packaging.

1. We recommend that you should assemble this product with the assistance of another person; this will make assembly easier, and will help eliminate damage to the product or injury to persons during assembly.
2. Be sure to check all packing materials carefully for small parts that may have come loose inside the carton during shipment.
3. Please do not over tighten screws or bolts.
4. Please put all parts on a non-abrasive floor before assembly, and follow the assembly steps to assemble your newly purchased product correctly and efficiently.

NO.	PART LIST		Q'TY
A	DISPLAY CABINET		1 Pc
B	GLASS SHELF		6 Pcs
C	LEGS (leveler)		4 Pcs
D	SUPPORT LEG (leveler)		1 Pc

NO.	HARDWARE LIST		Q'TY
<i>Pre-installed on Part 1</i>	Bolt 5/16"-18*2 1/4" <i>Pre-installed</i>		8 Pcs
	Spring Washer 5/16" <i>Pre-installed</i>		8 Pcs
	Flat Washer 5/16"*19mm <i>Pre-installed</i>		8 Pcs
	Threaded Washer 5/16"-18*19mm <i>Pre-installed</i>		8 Pcs
2	Allen Key 4mm		1 Pc
3	Tipping Restraint		1 Set
4	Glass Bumber		24 Pcs

**STEP 1:** Lay out all parts and hardware on a clean protective surface to protect the furniture and floor during assembly. Make sure the quantity of each is correct and the feet are free of stain, staples, screws and nail.

★ Remark:  
Anti-tip hardware must be installed by customer.  
Anti-tip hardware attached to the drawer of the back of product.

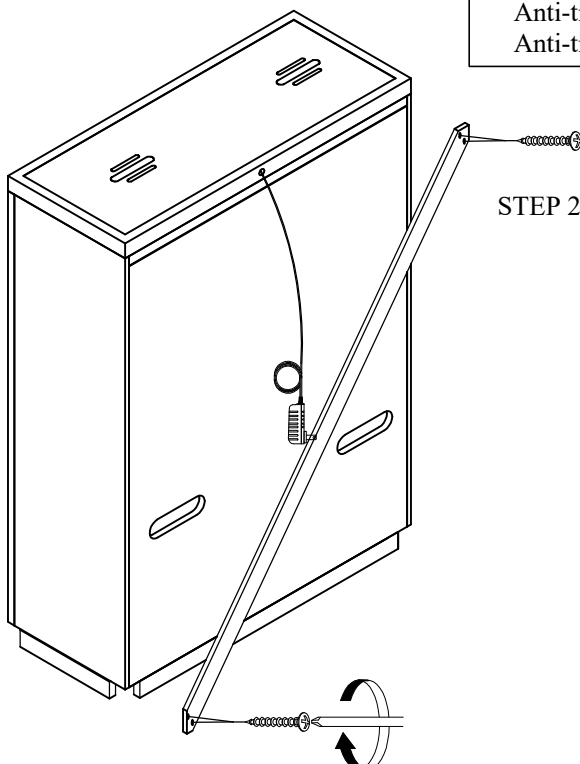

**STEP 2:** Remove the wooden piece at the back of the display cabinet (A).



Manufactured by LEGC for ROOMS TO GO

# ASSEMBLY INSTRUCTIONS

## LEGC 5413-570 DISPLAY CABINET - SKU: 42854136

Version 1: 05.09.2025

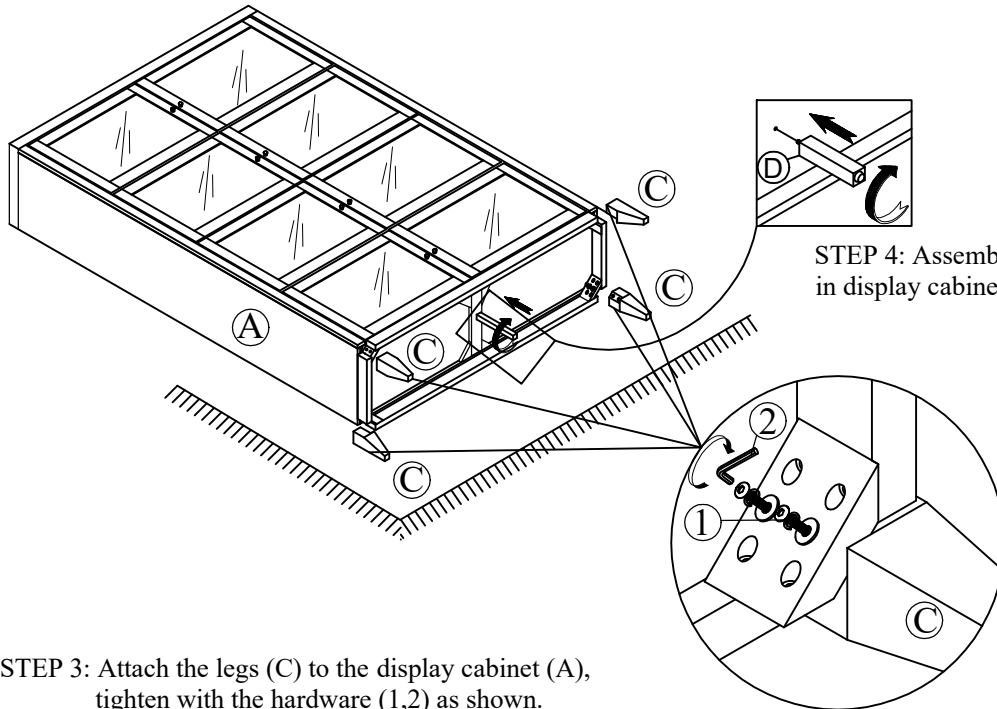

STEP 3: Attach the legs (C) to the display cabinet (A), tighten with the hardware (1,2) as shown.

STEP 4: Assemble Support leg (D) in display cabinet (A) as shown.

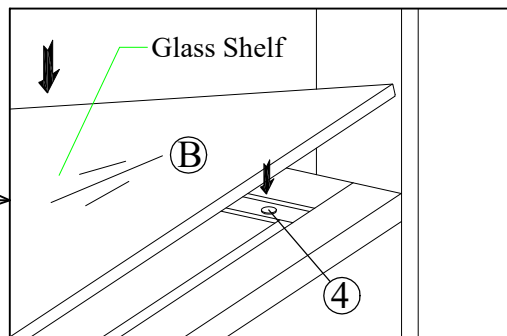
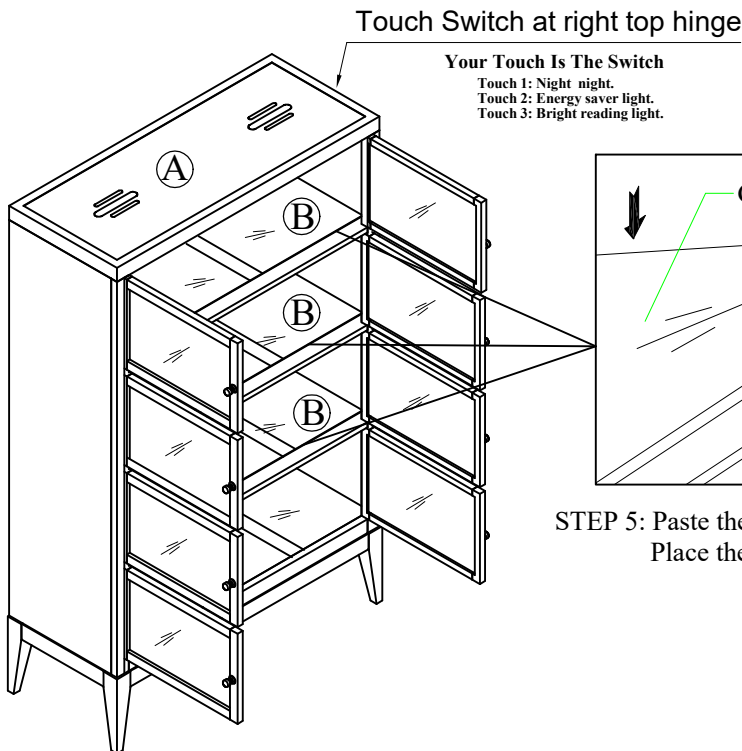

STEP 5: Paste the Glass bumper (4) on Display cabinet (A) frame. Place the glass shelf (B) into the Display cabinet (A) as shown.



Manufactured by LEGC for ROOMS TO GO

# ASSEMBLY INSTRUCTIONS

## LEGC 5413-570 DISPLAY CABINET - SKU: 42854136

Version 1: 05.09.2025

STEP 6: Install Tip Restraint, follow assembly instructions with the Tip Restraint.

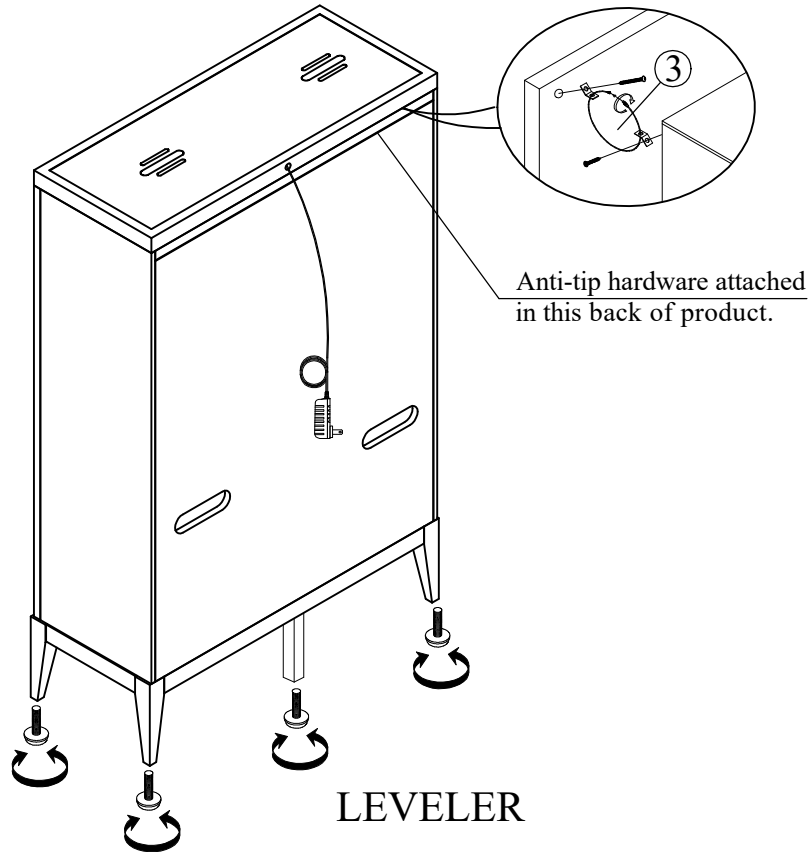

STEP 7: The levelers are pre-assembled, adjust leveler to firmly touch the floor.

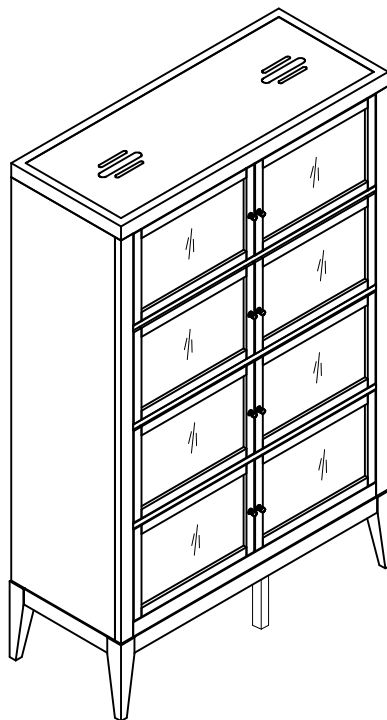



# WARNING

Misuse can result in FIRE or DEATH by ELECTRICAL SHOCK

**ELECTRICAL RATING (OUTPUT 12VDC/ 1.0A/12W)**

**Shenzhen Quanzhengtong Technology Co., Ltd**

**QZT-1201000**

**Read all instructions before using this furnishing.**

**DANGER — To reduce the risk of electric shock**

1. Always unplug this furnishing from the electrical outlet before cleaning or servicing.

**WARNING — To reduce the risk of burns, fire, electric shock, or injury to persons:**

1. Unplug from outlet before putting on or taking off parts.
2. Never operate this furnishing if it has a damaged electrical cord or plug, if it is not working properly, or if the electrical cord or plug has been damaged or dropped into water. Stop using this furnishing and call a service center for examination and repair.
3. Keep the electrical cord and plug away from heated surfaces and other heat sources.
4. To disconnect, turn all controls to the off position, then remove plug from outlet.
5. When operating, ensure that electrical cord is not under the base, legs, or motion mechanism to avoid damage to electrical cord or plug,
6. Do not strain or stretch electrical cord.
7. Do not use extension cords or power strips.
8. Keep out of reach of children. This is not a toy.
9. Plug directly into a compatible electrical socket.
10. Do not modify the plug or use any adapters.



# WARNING

El mal uso puede provocar INCENDIO o MUERTE por DESCARGA

**ELECTRICAL RATING (OUTPUT 12VDC/ 1.0A/12W)**

**Shenzhen Quanzhengtong Technology Co., Ltd**

**QZT-1201000**

**Leer todas las instrucciones antes de usar este mobiliario.**

**PELIGRO — Para reducir el riesgo de descarga eléctrica:**

1. Siempre desenchufe este accesorio de la toma de corriente eléctrica antes de limpiarlo o repararlo.

**ADVERTENCIA: para reducir el riesgo de quemaduras, incendios, descargas Eléctricas o lesiones a personas:**

1. Desenchufe del tomacorriente antes de colocar o quitar partes,
2. Nunca opera este accesorio si tiene un cable o enchufe eléctrico dañado, sino funciona correctamente, o si el cable o el enchufe eléctrico se ha dañado o se ha caído al agua. Deje de usar esie equipamiento y llame a un centro de servicio para que lo examinen y lo reparen.
3. Mantenga el cable eléctrico y el enchufe lejos de superficies calientes y otras fuentes de calor.
4. Para desconectar, gire todos los controles a la posición de apagado, luego retire el enchufe del tomacorriente.
5. Al operar, asegúrese de que el cable eléctrico no esté debajo de la base, las patas o el mecanismo de movimiento para evitar dañar el cable eléctrico o el enchufe.
6. No fuerce ni estire el cable eléctrico.
7. No utilizar cables de extensión o tomas de corriente.
8. Mantener fuera del alcance de los niños. Esto no es un juguete
9. Enchúfelo directamente a una toma de corriente compatible.
10. No modifique el enchufe ni utilice adaptadores.