







Assembly Instructions







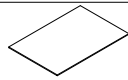
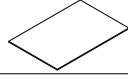

SSIO VD500WSV-R Vida Server

Manufactured by SSIO for Rooms To Go

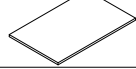
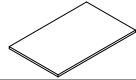
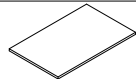
SKU:42958009

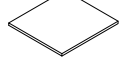
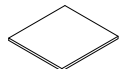
***Caution. Please read all instructions carefully before starting the assembly process. These parts are cumbersome and heavy. Therefore, two people are recommended in order to prevent personal injury and ensure the parts are not damaged during the assembly. Do not fully tighten screws & bolts until the entire item is completely assembled

Step	Code	Hardware	Qty
	A	SOCKET WRENCH 	1PC
1	B	BOLT Ø5/16"x20x2-1/2" 	8PCS
1	C	LOCK WASHER 	8PCS
1	D	FLAT WASHER 	8PCS

Part Number	Picturer	Des Cription	Material	Qty
PVD500WSV-RLBP		Left Back Panel	MDF+Ash Veneer	1PC
PVD500WSV-RRBP		Right Back Panel	MDF+Ash Veneer	1PC
PVD500WSV-RCBP		Central Back Panel	MDF+Ash Veneer	1PC
PVD500WSV-RLSD		Left side Door	MDF+Ash Veneer	1PC
PVD500WSV-RCD		Central Door	MDF+Ash Veneer	1PC
PVD500WSV-RRSD		Right Side Door	MDF+Ash Veneer	1PC
PVD500WSV-RCL		Central Leg	Rubber Wood	1PC
PVD500WSV-RSS		Side Shelf	PB+Ash Veneer	1PC
PVD500WSV-RCS		Central Shelf	PB+Ash Veneer	1PC
PVD500WSV-RL		Leg	Rubber Wood	4PCS
PVD500WSV-RSHIN		Side Hinge	IRON	4PCS
PVD500WSV-RSHIN		Middle Hinge	IRON	2PCS

Vida Dining Table
02/20/2023

SKU:42158003



Assembly Instructions SSIO VD500WSV-R Vida Server

Manufactured by SSIC for Rooms To Go

SKU:42958009

***Caution. Please read all instructions carefully before starting the assembly process. These parts are cumbersome and heavy. Therefore, two people are recommended in order to prevent personal injury and ensure the parts are not damaged during the assembly.

Do not fully tighten screws & bolts until the entire item is completely assembled

STEP#1

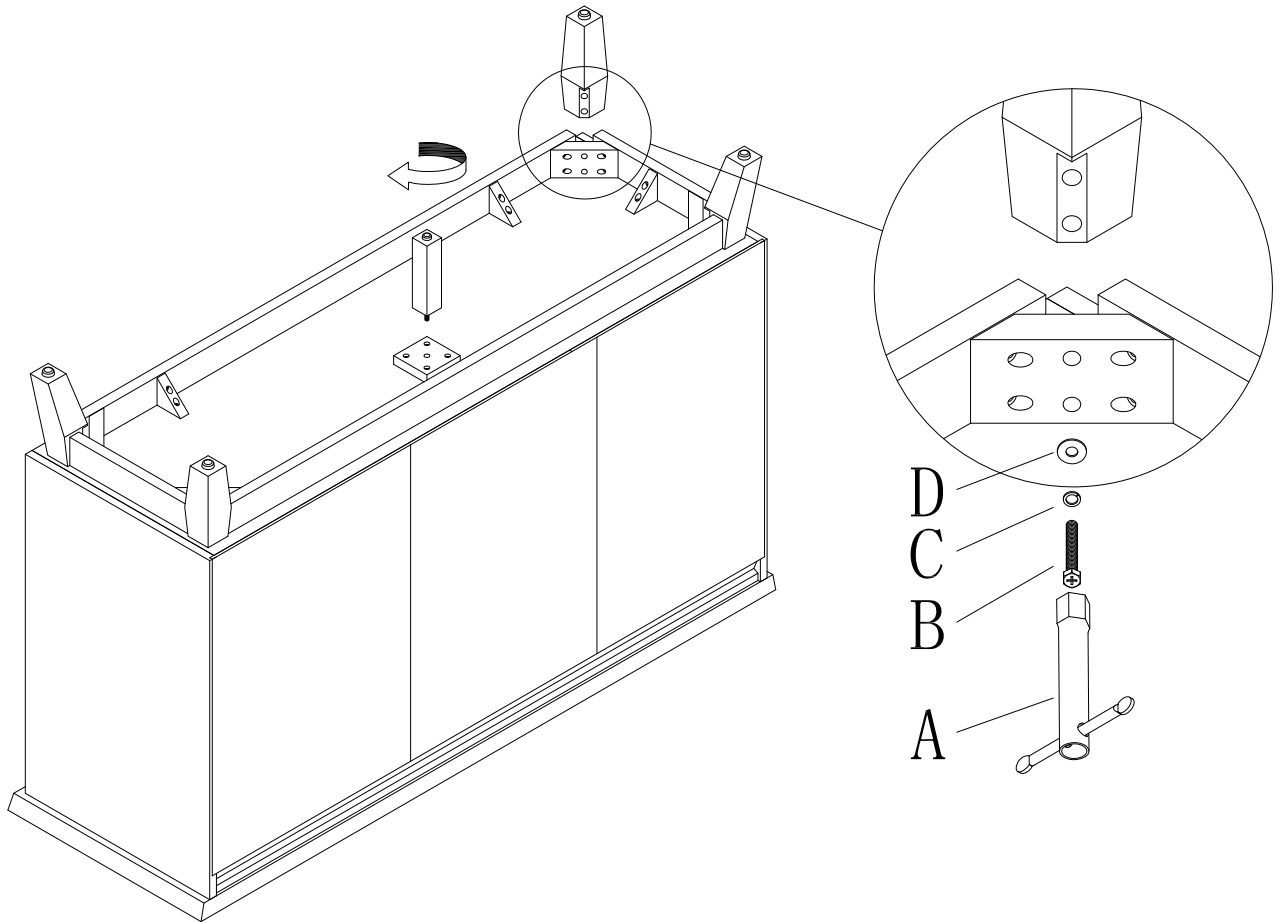

Vida Dining Table

SKU:42158003

02/20/2023



Assembly Instructions

SSIO VD500WSV-R Vida Server

Manufactured by SSIC for Rooms To Go

SKU:42958009

***Caution. Please read all instructions carefully before starting the assembly process. These parts are cumbersome and heavy. Therefore, two people are recommended in order to prevent personal injury and ensure the parts are not damaged during the assembly.

Do not fully tighten screws & bolts until the entire item is completely assembled

STEP#2

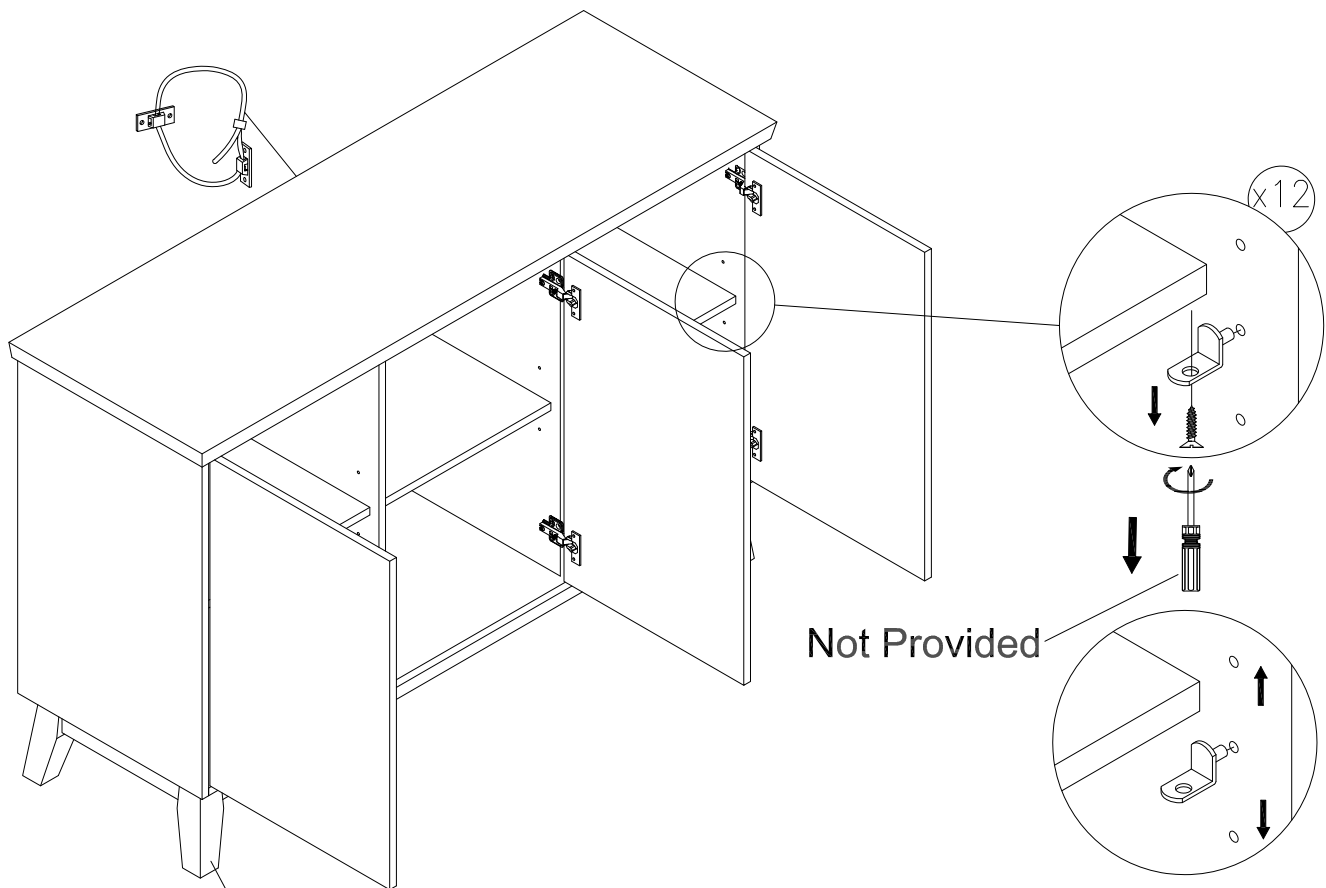

Adjust the Leveler as needed

1. Take off the screw on the shelf glide
2. Insert the shelf glide
3. Tighten the screw

Vida Dining Table

SKU:42158003

02/20/2023

Anti-Tipping Instructions

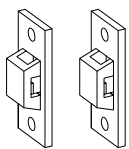
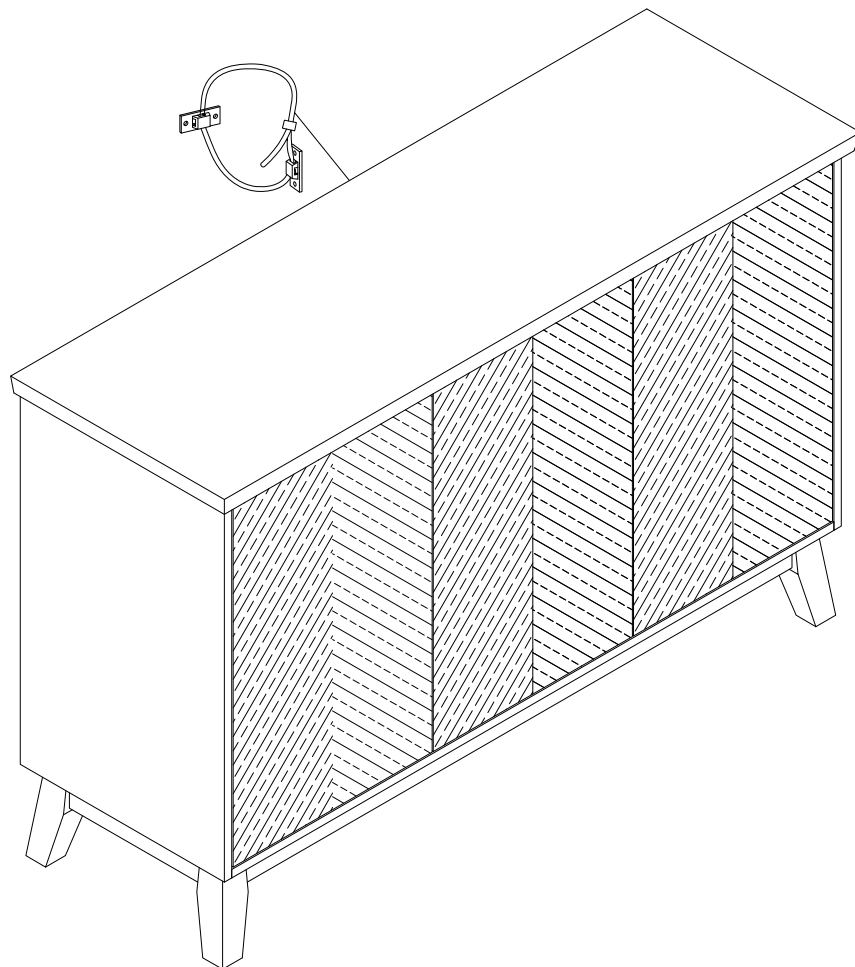
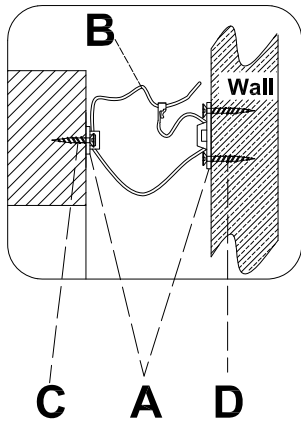

A x 2

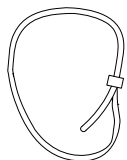

B x 1



C x 2



D x 2

Installation Instructions:

1. Attach a bracket to the wallboard with the long screws provided.
2. Attach a bracket to the furniture frame under the top with the short screws provided.
3. Move the furniture into its final position. Thread a strap through the bracket as shown in the illustration, tighten strap until snug. Do not over tighten.
4. Make sure the bracket is firmly attached to the wallboard and furniture, and the strap is snug.

Instrucciones anti-vuelco

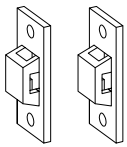
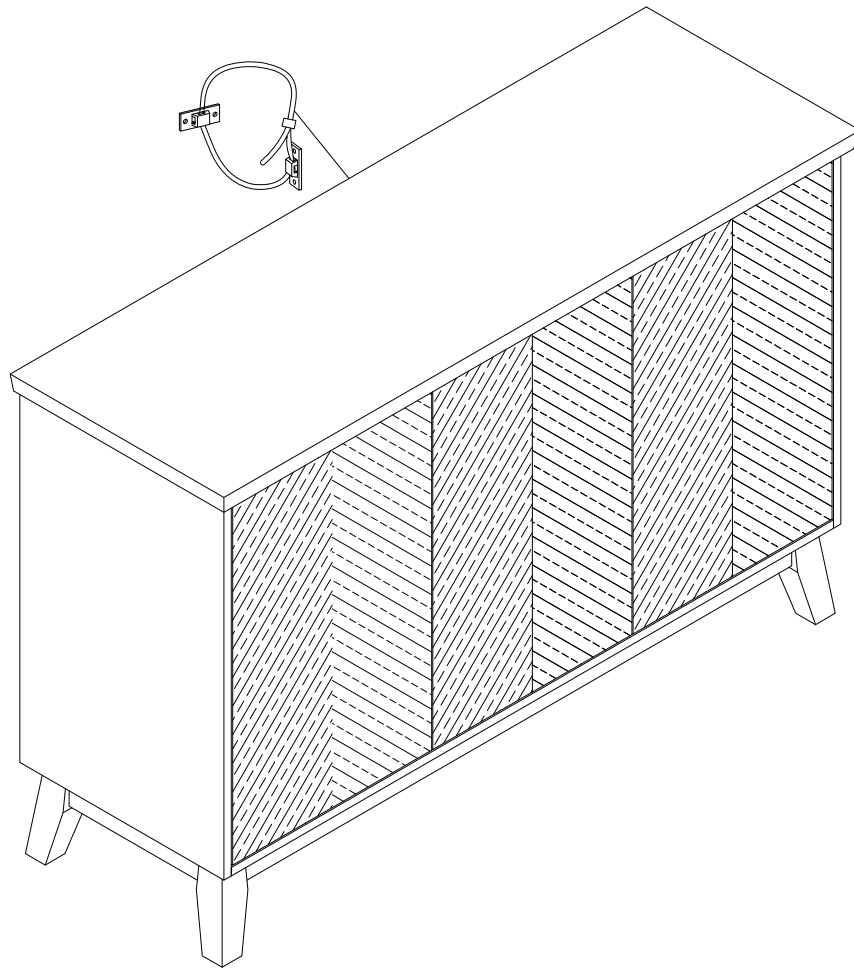
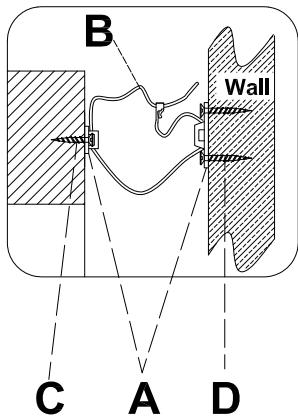

A x 2

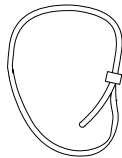

B x 1



C x 2



D x 2

Instrucciones de instalación:

1. Adjuntar un soporte al tablero de pared con los tornillos largos proporcionados.
2. Adjuntar un soporte al marco del mueble debajo de la parte superior con los tornillos cortos proporcionados.
3. Mueva los muebles a su posición final. Pase una correa por el soporte como se muestra en la ilustración, apriete la correa hasta que quede ajustada. No apriete demasiado.
4. Asegúrese de que el soporte esté firmemente sujeto al tablero y los muebles, y que la correa esté ajustada.

Instructions anti-basculement

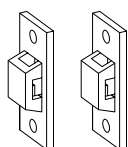
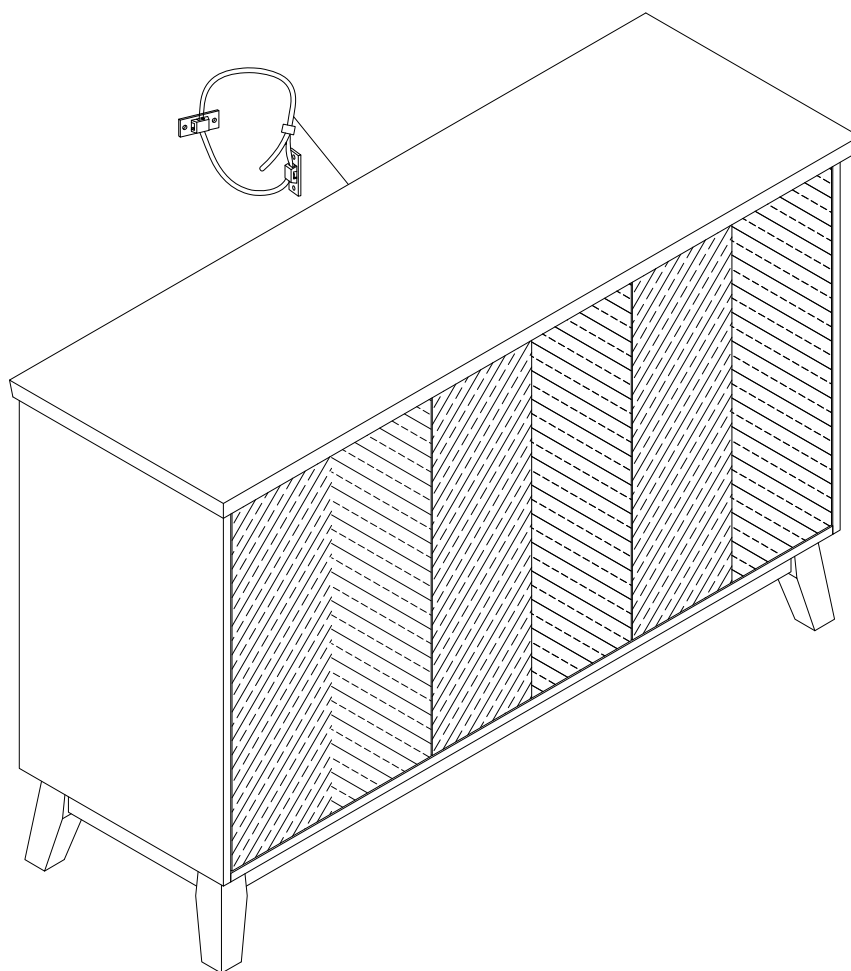
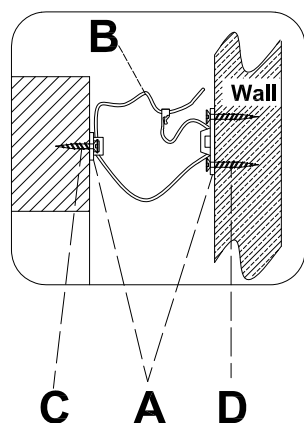

A x 2



B x 1



C x 2



D x 2

Instructions d'installation:

1. Fixez un support au panneau mural avec les longues vis fournies.
2. Fixez un support au cadre du meuble sous le dessus avec les vis courtes fournies.
3. Déplacez le meuble dans sa position finale. Faites passer une sangle à travers le support comme indiqué sur l'illustration, serrez la sangle jusqu'à ce qu'elle soit bien ajustée. Ne pas trop serrer.
4. Assurez-vous que le support est fermement fixé au panneau mural et aux meubles et que la sangle est bien ajustée.