

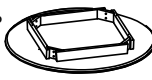



Thanks you for purchasing this quality product. Be sure to lay all components on a soft and clean surface before assembly in order to avoid components from being scratched.

**CAUTIONS :**

1. Check contents against list for quantity.
2. Familiarize yourself with the components and hardware by reviewing the Assembly Instructions.
3. Do not over tightened the screws and bolts as it may damage the threads.
4. Keep all hardware parts out of the reach of children.
5. Please "LIFT UP & MOVE" the chair when ever you want to shift it.

PARTS LIST		
NO.	DESCRIPTION	QTY
1	TABLE LEG 	4 PCS
2	TABLE TOP 	1 PC

HARDWARE LIST		
NO.	DESCRIPTION	QTY
A	JCBC M6 x 70mm 	8 PCS
B	FLAT WASHER 	8 PCS
C	SPRING WASHER 	8 PCS
D	ALLEN KEY M4 	1 PC

**STEP 1**

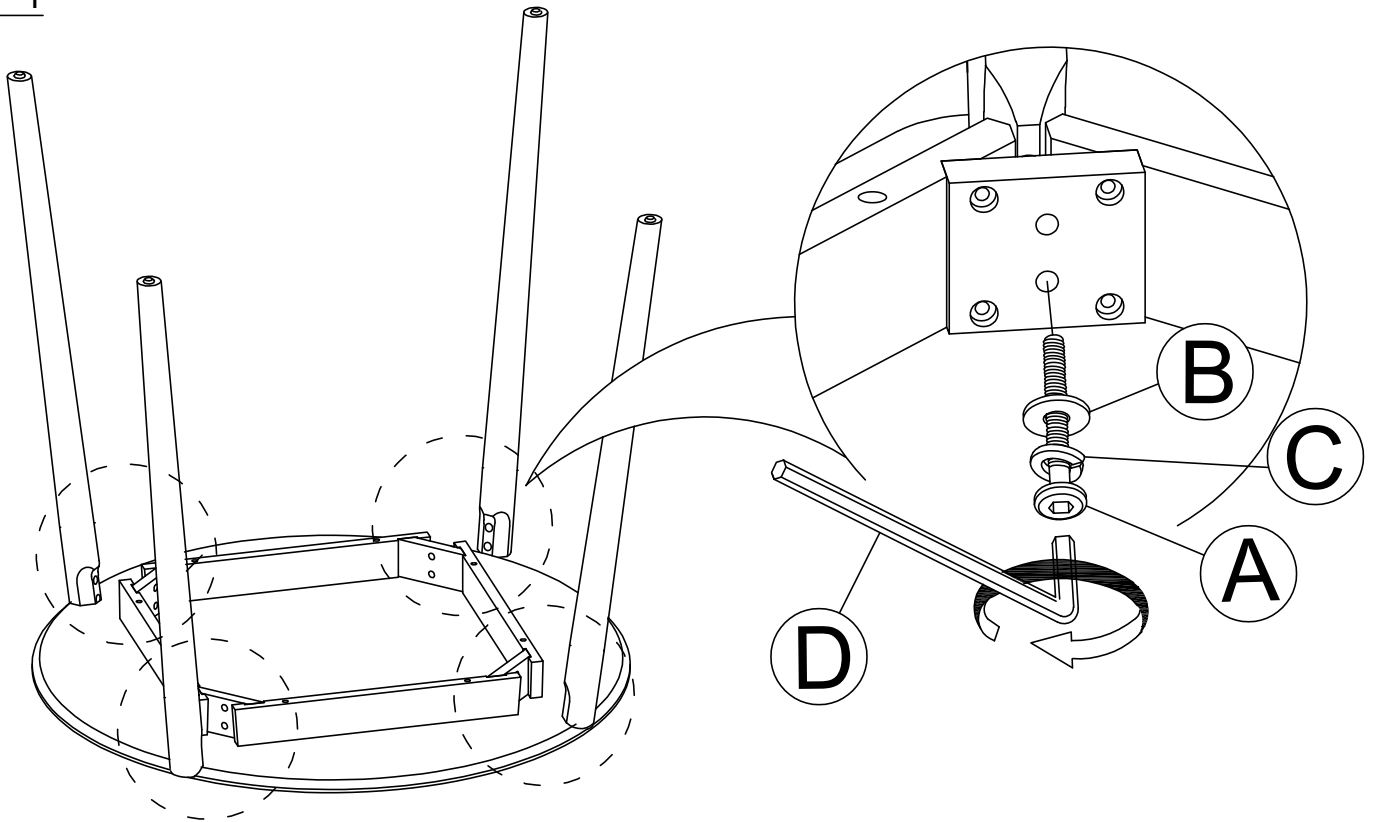

**COMPLETED ASSEMBLY**