





Assembly Instructions

CRWN 2410S-N SIDE CHAIR

SKU# 43424100

Step	Code	Hardware		Q'TY
	A	WRENCH ϕ 5/16		1PCS
	B	GLUE		1PCS
1	C	EXTRA LONG BOLT ϕ 5/16"*18*3"		4PCS
		LOCK WASHER ϕ 5/16		4PCS
		FLAT WASHER ϕ 5/16		4PCS
2	D	LONG BOLT ϕ 5/16"*18*2-1/2"		4PCS
		LOCK WASHER ϕ 5/16		4PCS
		FLAT WASHER ϕ 5/16		4PCS
3	E	SHORT BOLT ϕ 5/16"*18*1-1/2"		2PCS
		LOCK WASHER ϕ 5/16		2PCS
		FLAT WASHER ϕ 5/16		2PCS
4	F	SCREW ϕ 8#*1-1/2"		6PCS

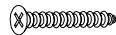
Parts List

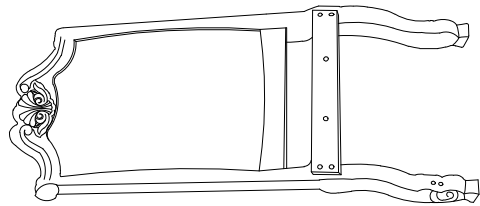

1. Chair Back

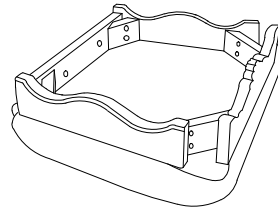

2. Seat Frame

Right



Left

3. Front Leg

Right

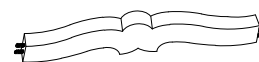

Left



Center

4. Stretcher

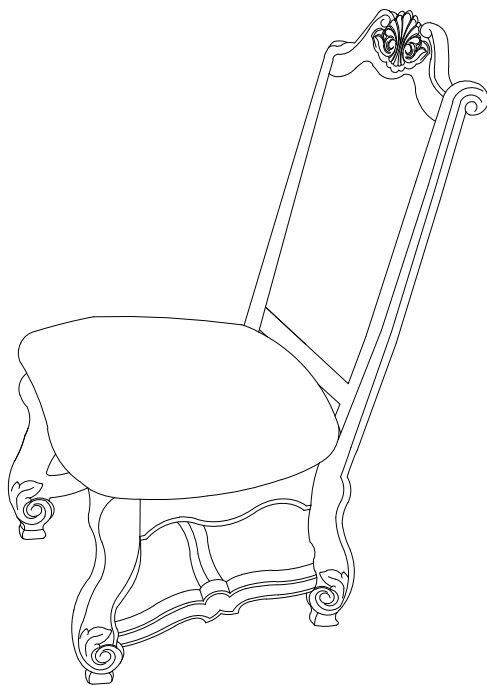

Hardware Pack Location(s):

Side Chair, SKU# 43424100

Assembly Instructions

CRWN 2410S-N SIDE CHAIR

SKU# 43424100

****Cautions. Please read all instructions carefully before starting the assembly process. These parts are cumbersome and heavy. Therefore two people are recommended in order to prevent personal injury and ensure the parts are not damaged during the assembly.

STEP: 1

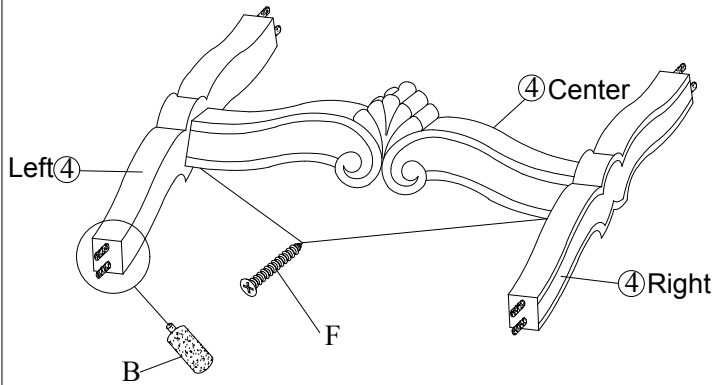

Attach Center Stretcher to Right Stretcher and Left Stretcher with screws and tighten them with a phillips head screwdriver. Use the glue to join the stretcher. (A phillips head screwdriver is not included.)

STEP: 2

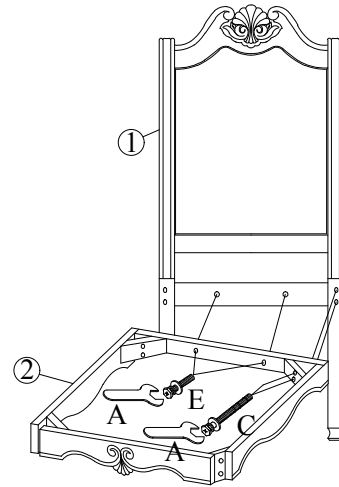

Attach Cushion to Chair Back with Short Bolts, Long Bolts, Lock Washers, and Flat Washers. Note: Do not tighten bolts until all of them are in place.

STEP: 3

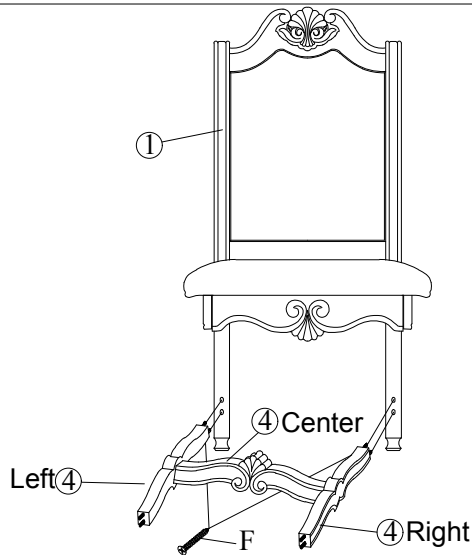

Attach all Stretcher to Chair Back with Screws.

STEP: 4

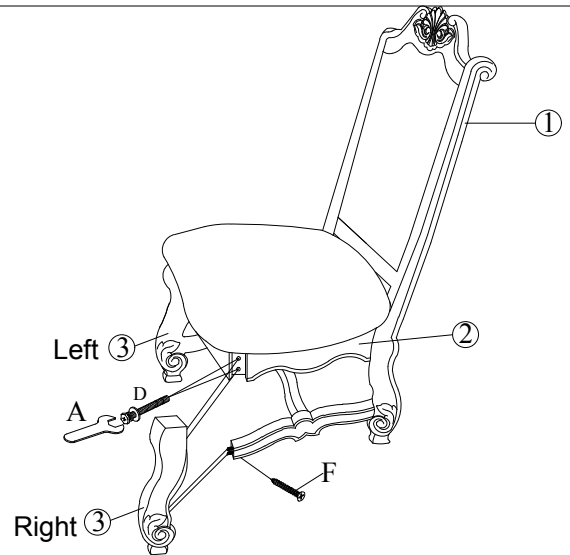

Attach Right Front Leg to Seat Frame Cushion with Long Bolt and then Attach Front Right Leg to Stretcher with Screw. Do the same way with the left side.