

ASSEMBLY INSTRUCTION

EMRI 2582-54 SKU # 43525825
 EMRI 2582-56 SKU # 43525837
 EMRI 2582-59 SKU # 43525813
COUNTER HEIGHT BENCH

Thank you for purchasing this product. Be sure to check all packing materials carefully for small parts that may have come loose inside the carton during shipment.

Before You Assemble: Please read all instructions carefully before beginning assembly. It is recommended that 2 people work together during assembly to prevent personal injury and to ensure that heavy or cumbersome parts are not damaged during the process.



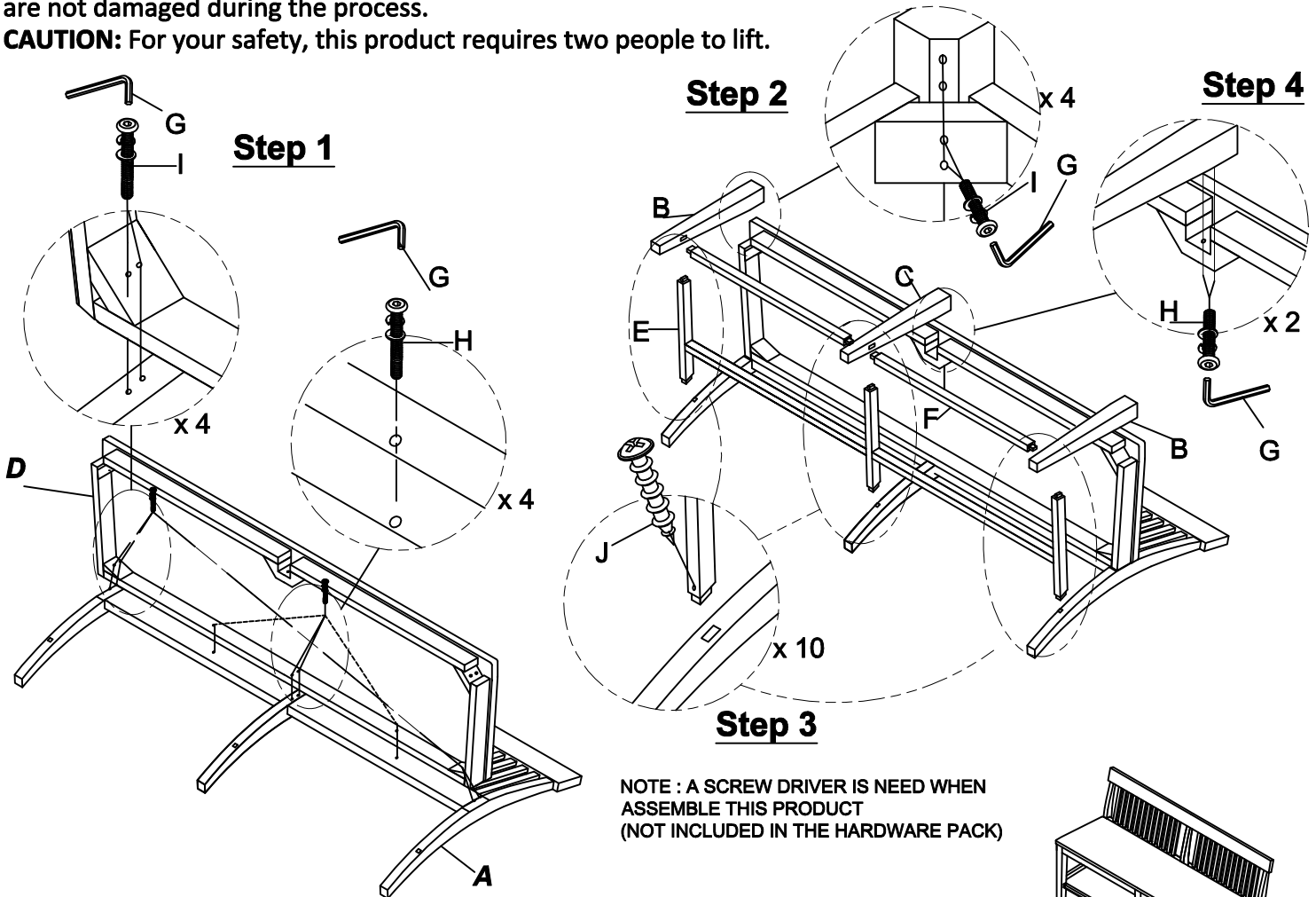

CAUTION: For your safety, this product requires two people to lift.

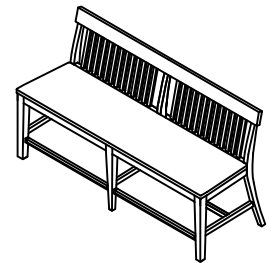

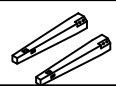

NOTE : A SCREW DRIVER IS NEEDED WHEN ASSEMBLE THIS PRODUCT (NOT INCLUDED IN THE HARDWARE PACK)

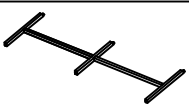

NOTE : WAIT TO TIGHTEN ALL COMPONENTS COMPLETELY UNTIL UNIT IS FULLY ASSEMBLED. THIS WILL ALLOW FOR EASIER ASSEMBLY.

PICTURE	DESCRIPTION	Q'TY
A 	BACK CHAIR EHF # N/A	1pc
B 	LEGS L / R EHF # LEGS L/R	2pcs
C 	CENTER LEG EHF # CTRLEG	1pc
D 	SEAT EHF # N/A	1pc
E 	CENTER CROSS RAIL EHF # CR STR	1set
F 	FRONT CROSS RAIL EHF # CR STR	2pcs

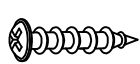
PICTURE	DESCRIPTION	Q'TY
G 	ALLEN KEY 20*60*4mm EHF # HDWR	1pc
H 	BOLT 5/16"*18* 1 3/4" EHF # HDWR	6pcs
I 	BOLT 5/16" *18* 3 1/4" EHF # HDWR	8pcs
J 	SCREWS 4 X 1 1/2" EHF # HDWR	10pcs