

Assembly Instructions

Sofia Vergara
COLLECTION







NAJA CRZEN2SC





43774012 7401-10 WD BK CNT HGT STOOL WHITE CHERRY

Thank you for purchasing this quality product. Be sure to check all packing materials carefully for small parts, which may have come loose inside the carton during shipment. Identify and count all parts and compare with the **HARDWARE LIST** below.

Caution: Please read instructions thoroughly before unpacking assembly parts.

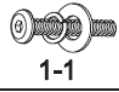
1. We recommend that you assemble this product with the assistance of another person; this will make assembly easier, and will help to eliminate damage to the product or injury to persons during assembly.
2. Please do not over tighten screws or bolts until the assembly is completed.
3. Please put all parts on a non-abrasive floor before assembly, and follow the assembly steps to assemble your newly purchased product correctly and efficiently.

NO.	PARTS LIST		Q'TY
A		Chair back	1
B		Seat	1
C		Left Front Leg	1
D		Right Front Leg	1
E		Left Side Stretcher	1
F		Right Side Stretcher	1
G		Front Stretcher	1

NO.	HARDWARE LIST		Q'TY
1		Ø5/16" x 18 x 38mm L Bolt	2
		5/16"x 13x2mm Spring washer	
		5/16"x 22x2mmT Flat washer	
		Ø5/16" x 18 x 75mm L Bolt	4
5/16"x 13x2mm Spring washer			
5/16"x 22x2mmT Flat washer			
		Allen wrench (4mm)	1
2		Ø5/16" x 18 x 63.5mm L Bolt	4
		5/16"x 13x2mm Spring washer	
		Ø4 x 45mm pan head screw	6

Step 1

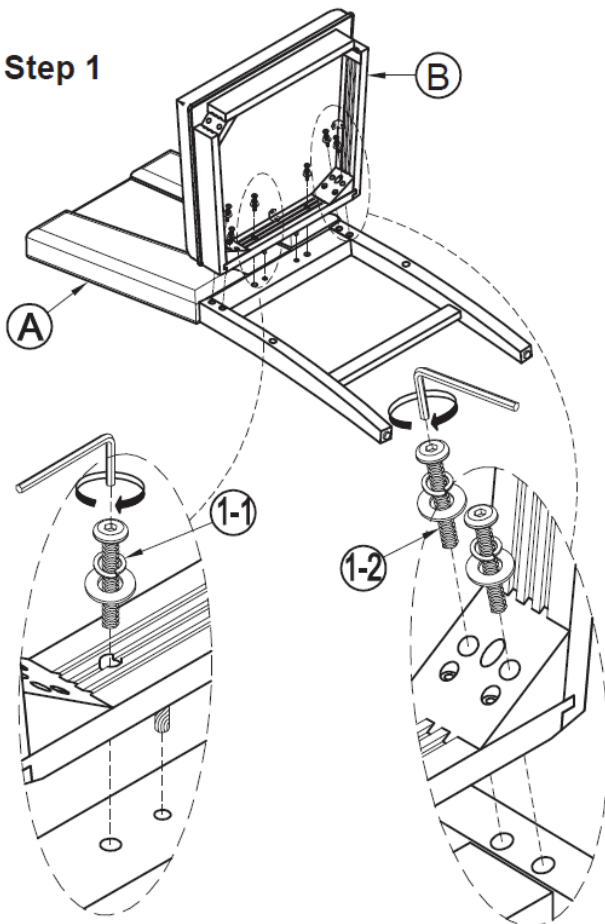

Step 2

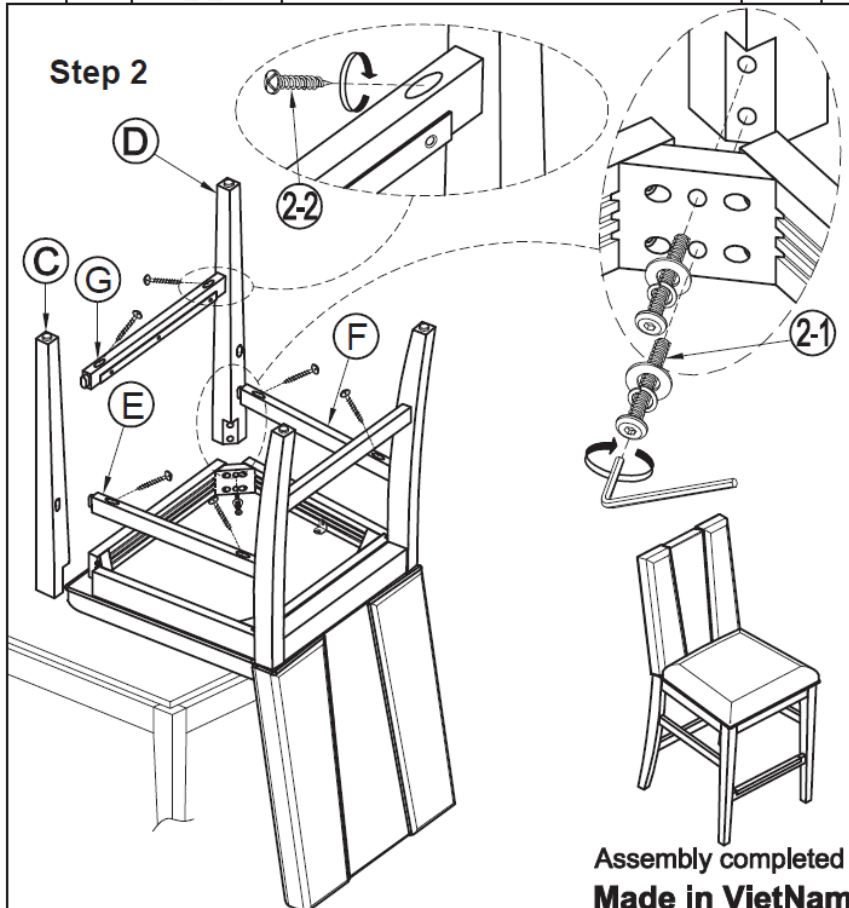

Assembly completed
Made in Vietnam

CARING FOR YOUR FURNITURE

Protect your investment

The beauty of furniture care is that it helps to protect your investment, as fine furniture is an important purchase.

Proper care will help maintain your furniture's finish and ensure that it looks great year after year.

Caring for furniture

Caring for furniture is easy. Following a few simple guidelines will help extend the life of your furniture.

- Always dust with a cloth moistened with polish. Polish cushions the cloth, eliminating the scratching that occurs with dry dusting. Dust will scratch furniture if not removed quickly. Use a soft clean cloth that won't scratch the surface. Avoid coarse or scratchy materials or fabrics.
- Avoid using soap and water on furniture. Water can penetrate the finish and raise the grain on wood. Causing damage.

The Enemies of Furniture

Many common problems in furniture care are caused by the elements. If you are aware of these troublemakers, the resulting damage can easily be avoided.

- Sunlight's ultraviolet rays can damage wood finishes. Arrange furniture out of direct sunlight use sun screening drapes during intense sunlight hours, rotate furniture in place and room arrangement.
- Liquid spills will damage furniture if not removed promptly. Use coasters under beverage glasses and saucers under cups and flowerpots. If a spill occurs, immediately blot it gently without rubbing the surface.
- Heat creates a chemical change in the furniture finish, which can result in a white spot. Use protective mats under hot dishes, utensils or cooking appliances.
- Cyclic changes in temperature can damage furniture. Placing furniture near to central heating radiators and air ducts should be avoided because this causes extreme localized drying of the wood.

Tips for Better Dusting

- Be sure to use the same type of polish consistently. Your furniture will appear cloudy or streaky if oil based or wax based polishes are interchange.
- Always use a fine furniture polish when dusting. Never dry dust, as it could cause microscopic scratches on your furniture's surface. Remember to change dusting cloths frequently since a dirty cloth may scratch your furniture's surface.
- Spray your furniture surface evenly, but not too generously. Wipe in a circular motion with a soft clean cloth to clean and loosen old polish.
- Then buff until completely dry for a beautiful shine and a smudge free finish. For wood trim spray polish on the cloth first, then dust.