

ASSEMBLY INSTRUCTIONS

SUN VALLEY SOFA
EXGM SKU 70117013

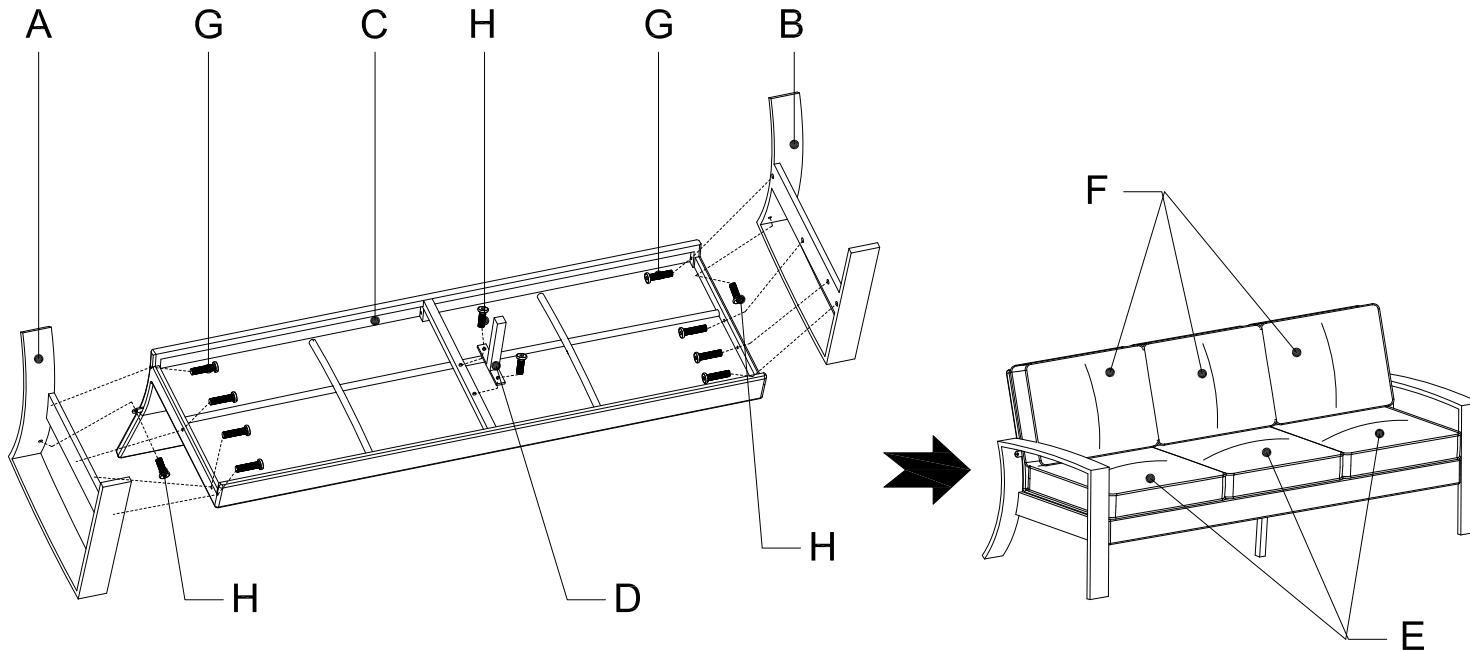

STEP 1: Place the Seat & Back Frame (C) upside down on a clean and soft surface







STEP 2: Assemble Left & Right Arm Frames (A & B) to the SEAT DECK of the Seat & Back Frame (C) by Long Bolts (G) loosely tightened with Allen Key (I).

STEP 3: Assemble Left & Right Arm Frames (A & B) to the BACK DECK of the Seat & Back Frame (C) by Short Bolts (H) loosely tightened with Allen Key (I).

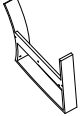
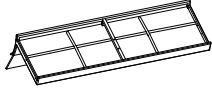
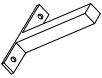
STEP 4: Tightened all the screws.

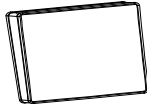
STEP 5: Assemble the Center Leg (D) to the underneath of the center of the seat deck by Short Bolts (H), tightened the screws.

STEP 6: Turn the sofa to normal position and place the Seat & Back Cushions (E & F). Your furniture is ready to use.

NO.	PICTURE	DESCRIPTION	QTY
A		Left Arm Frame	1
B		Right Arm Frame	1
C		Seat & Back Frame	1
D		Center Leg	1
E		Seat Cushion	3
F		Back Cushion	3
G		Long Bolt 1/4"x24x1-2/5"	8
H		Short Bolt 1/4"x24x3/5"	4
I		Allen Key	1