

# ASSEMBLY INSTRUCTIONS



 2222-1 *TESSERE GRAY SOFA W THROW PILLOWS/*

 2223-1 *TESSERE BLUE SOFA W THROW PILLOWS*

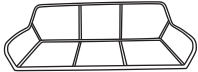
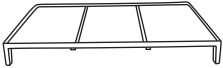
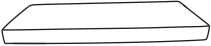

SKU: 70122228/ 70122230

Thanks for purchasing this quality product. Be sure to check all packing materials carefully for small parts, which may have come loose inside the carton during shipment. Identify and count all parts and compare with the Hardware List below

**PARTS LIST**

NO.:	PIC	DESC	QTY
A		Seat Part	1pc
B		Leg Part	1pc
C		Seat Cushion	1pc
D		Back cushion	3pcs
E		Pillow cushion	2pcs

**PARTS LIST**

NO.:	PIC	DESC	QTY
F		Bolts M6x20	6pcs
G		Spring washer M8	6pcs
H		Washer M6	6pcs
I		Allen Key 4x8mm	1pc

# ASSEMBLY INSTRUCTIONS

2222-1 TESSERE GRAY SOFA W THROW PILLOWS/

2223-1 TESSERE BLUE SOFA W THROW PILLOWS

SKU: 70122228/ 70122230

Thanks for purchasing this quality product. Be sure to check all packing materials carefully for small parts, which may have come loose inside the carton during shipment. Identify and count all parts and compare with the Hardware List below

Step 1: Place the Seat part (Part A) on the clean, soft surface as a blanket or carpet. Assemble the Leg part (Part B) to the Seat part by Bolts, Spring washers, Washers M6 (Part F, G, H) and loosely tightening with Allen key (Part L). When inserting the bolts, loosely tighten each about 5-6 full turns and ensure each of the 4 bolts fit well. Once all 4 are inserted and loosely tightened, proceed to fully tighten each bolt.

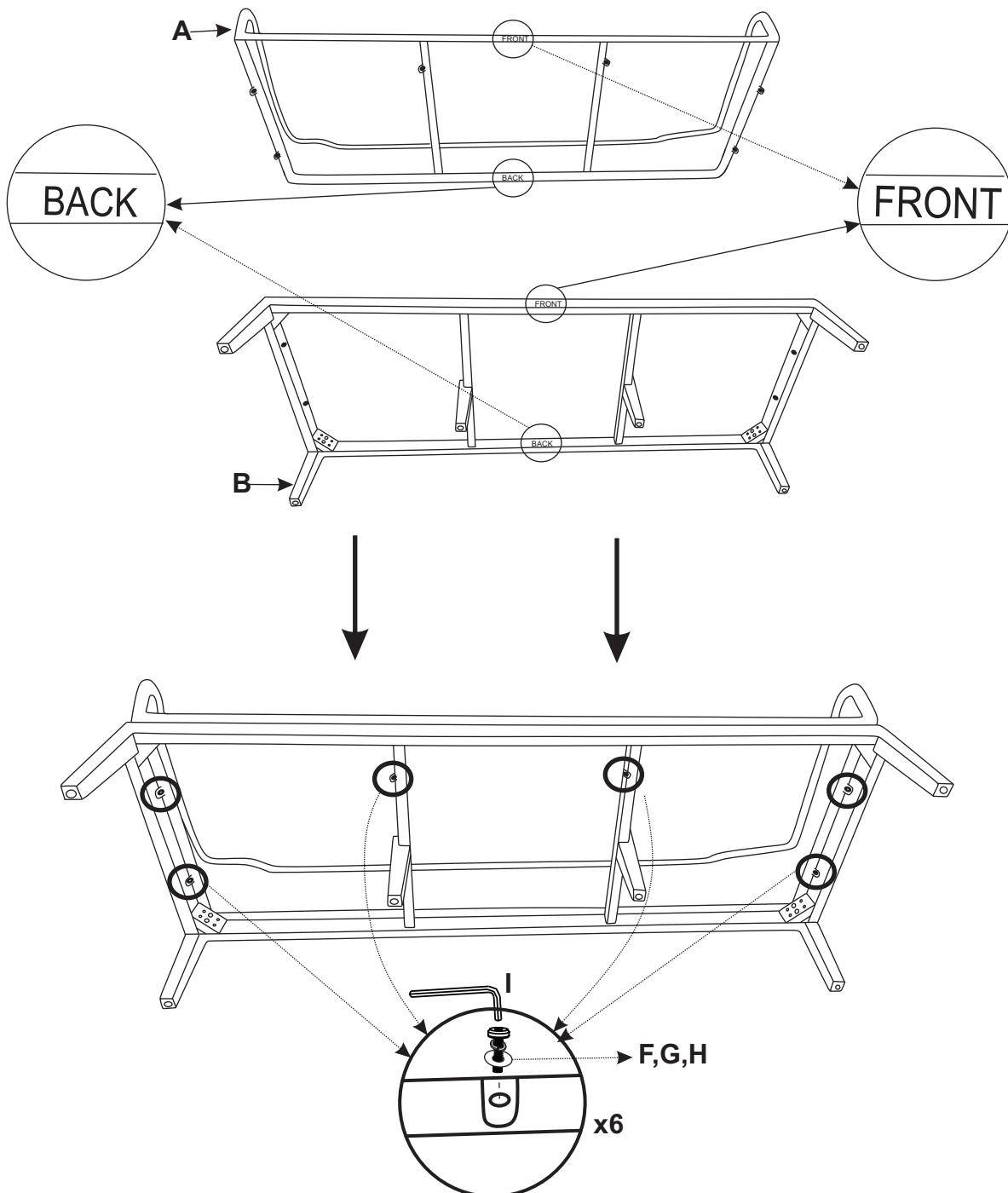

## ASSEMBLY INSTRUCTIONS

2222-1 *TESSERE GRAY SOFA W THROW PILLOWS/*

2223-1 *TESSERE BLUE SOFA W THROW PILLOWS*

SKU: 70122228/ 70122230

Step 2: After assembly, put the seat cushion (Part C), back cushions (D) and pillows (E) on product and your product is ready to use.

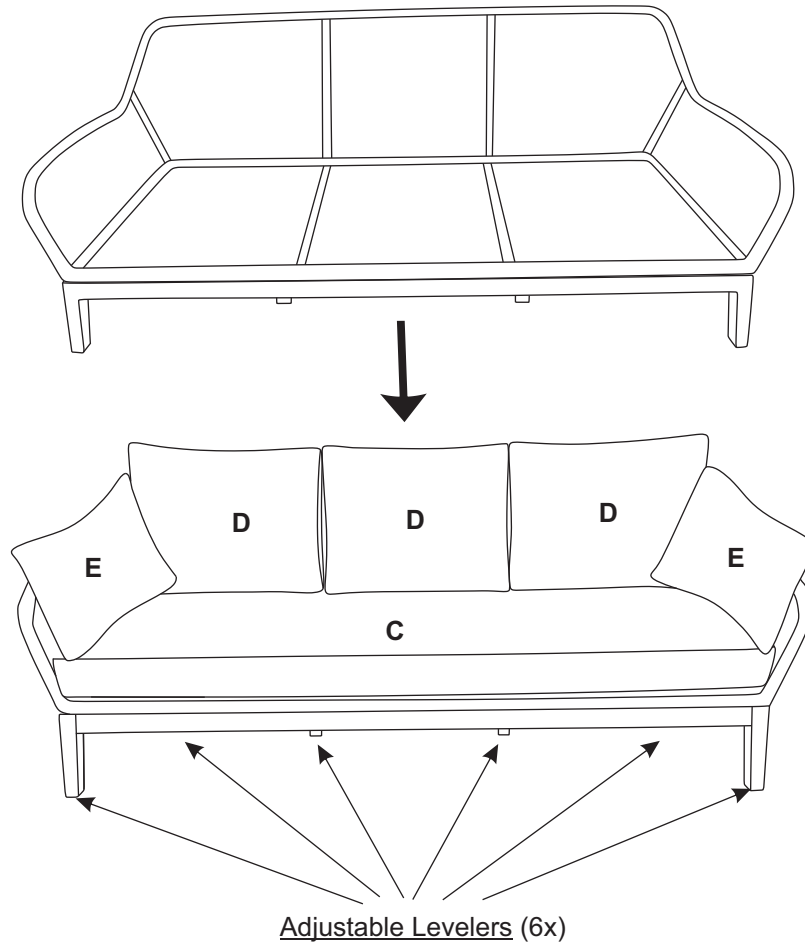

Periodically check and make sure all bolts are fully tightened.

**Assembly Completed**