

Assembly Instructions











Identify all parts packed in the carton against the parts list. Remove all protective materials. Place parts on a non-abrasive surface to avoid scratching.

Do Not Attempt Assembly If Any Parts Are Missing Or Damaged.

Warning: Please do not use acid or alkaline washing liquid to clean the product.

Assemble the product as shown below, step-by-step.

Part List

NO.	SKETCH	DESCRIPTION	QTY	NO.	SKETCH	DESCRIPTION	QTY
A		Back Frame	1	AA		M6x20 Bolt	14
B		Seat Frame	1	BB		Washer	14
C-L		Left Arm	1	CC		Bolt Cover	14
C-R		Right Arm	1	DD		Wrench	1
D		Back Cushion	3	EE		Foot Glider	4
E		Seat Cushion	3				

STEP 1

Hand tighten nut 3-4 revolutions only ,do not tighten all the bolts and nuts.

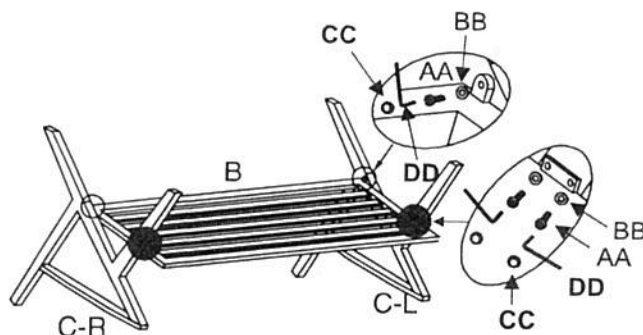

JWUA GL3A-5147-123KD

Made in China

STEP 2

Hand tighten nut 3-4 revolutions only ,after attached all the bolts, adjust all the part at correct position,then tighten all the bolts and nuts. Do not over tighten.

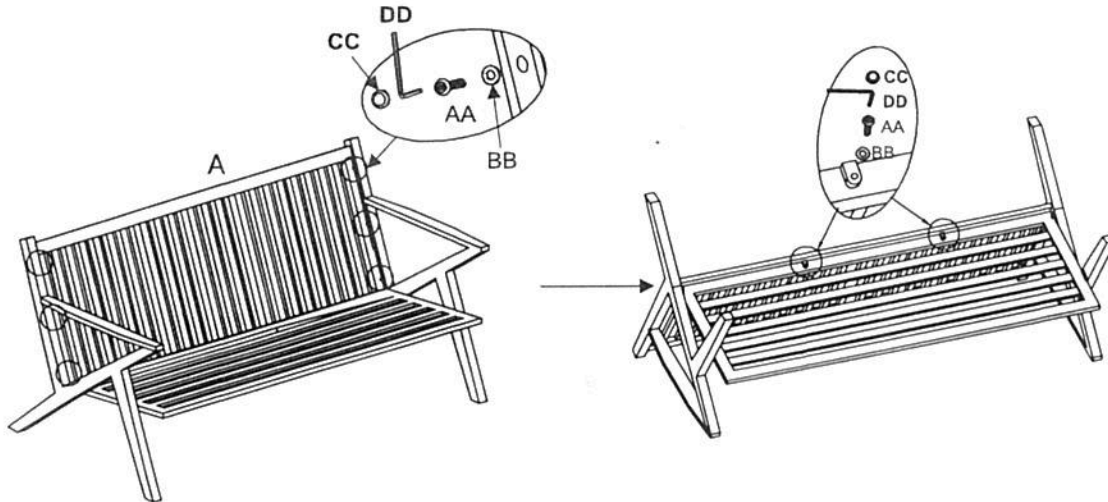

STEP 3

Need two people turn the sofa right side up.adjust the pre-installed foot glider(EE) at the end of each sofa leg until the sofa is level with the ground securely, Your sofa is ready for use

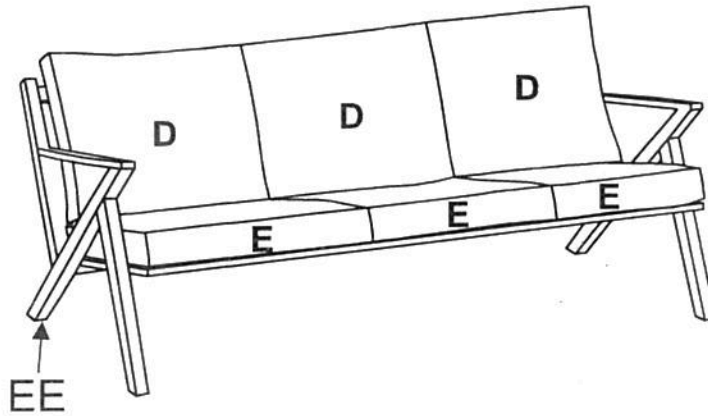

2

*DO NOT OVER TIGHTEN

*NO SOCKET DRIVERS



*NO POWER TOOLS

