

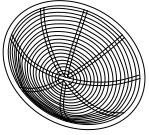

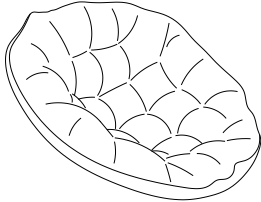

ITEM NAME/NOM D'ITEM: PAZ ACCENT CHAIR

ITEM # /NO. ITEM: 703973

PARTS LIST/LISTE DES PIÈCES

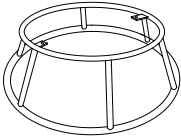
(1)	(3)	(4)
 <p>x1</p>	 <p>x1</p>	<p>A.  M6x20mm x2</p>
<p>(2)</p>		<p>B.  Ø10x1mm x2</p>
 <p>x1</p>		<p>C.  4mm x1</p>

ASSEMBLY INSTRUCTIONS/INSTRUCTIONS D'ASSEMBLAGE

I

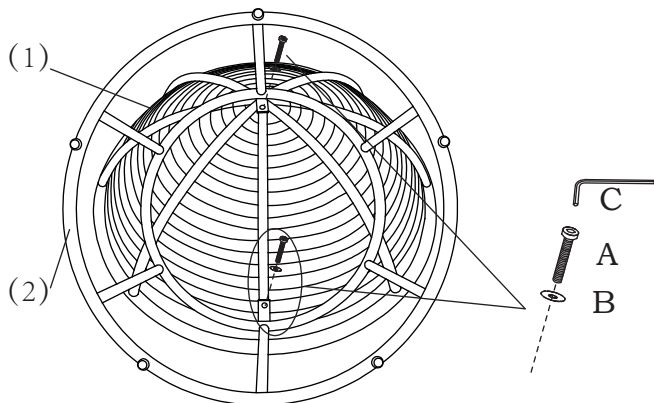

II

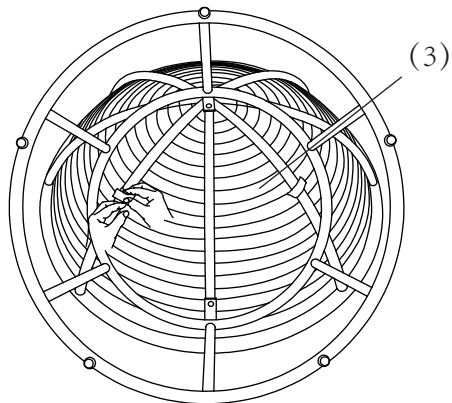

III

