

Item # : OREGGCH

Assembly Instructions

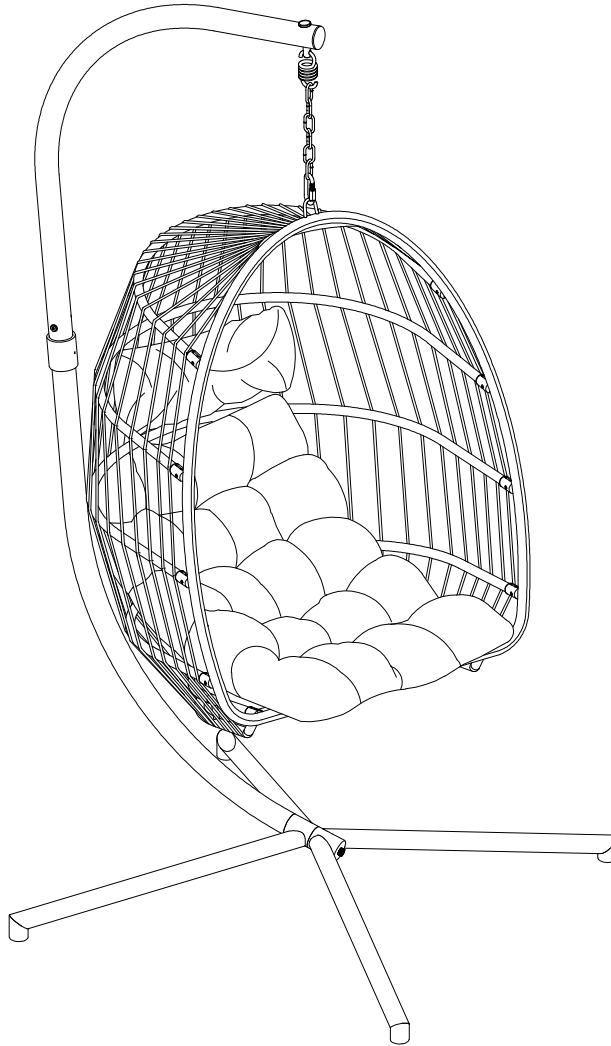

Walker Edison®

Please visit our website for the most current instructions, assembly tips, report damage, or request parts. www.walkerediton.com

Revised 20/12/2019 (E)

Outdoor Furniture Care / Cleaning Guidelines

Our patio furniture is designed to be enjoyed for years to come, and while many of our products are weather resistant, UV protected, and water resistant, they still need some care to keep them looking great. Follow these simple tips to maintain the function and appeal of these products.

- I. **Wood Products** - To maintain the attractive coloring and natural wood grain of acacia products, we recommend applying teak oil, at the beginning and the end of each patio season. Teak oil is available at your local hardware store. We also recommend that acacia products are covered when not in use.
- II. **All-Weather / Metal Products** - To keep these products clean and looking sharp, we recommend washing these products as needed with warm, soapy water and wipe down with a clean, dry cloth.
- III. **Cushions** - To clean our comfortable cushions, we recommend pulling the cover off of the cushion and washing on the gentle cycle in your washing machine. It is also recommended that the cushion covers are air dried.







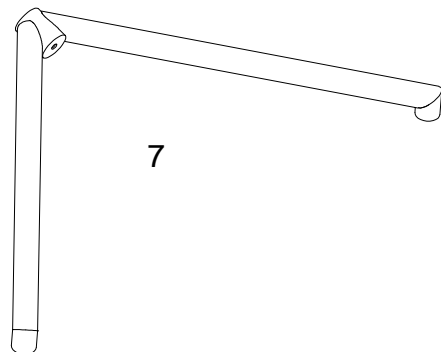
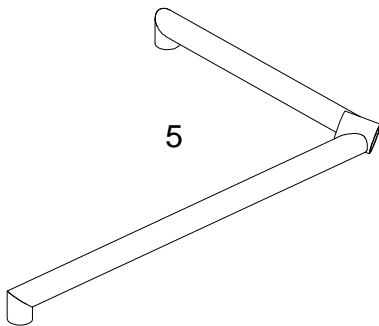
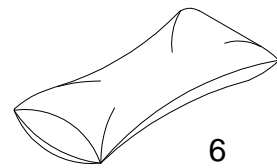
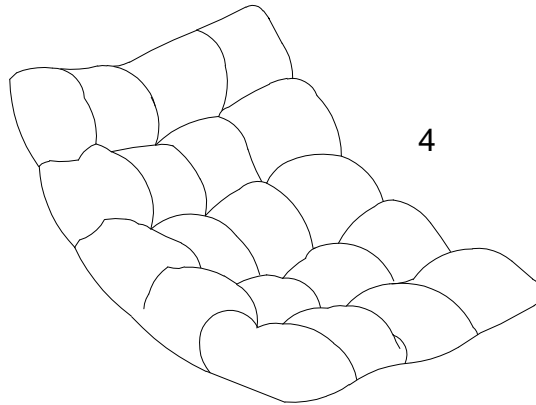
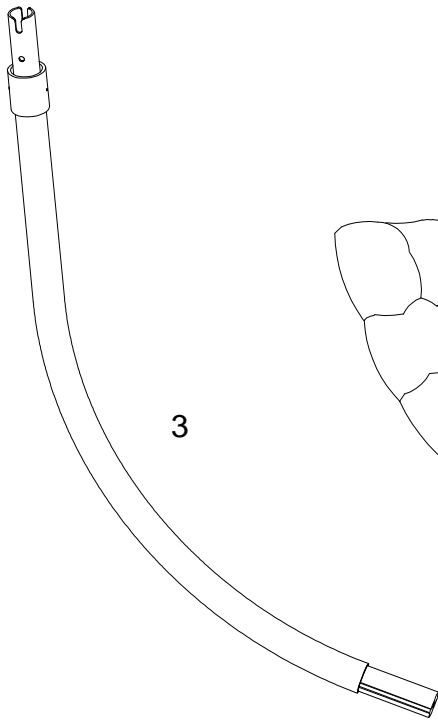
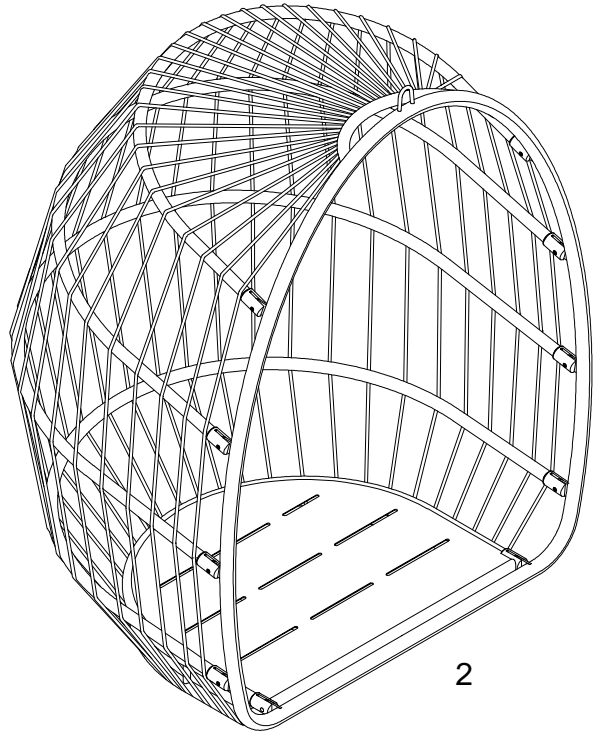
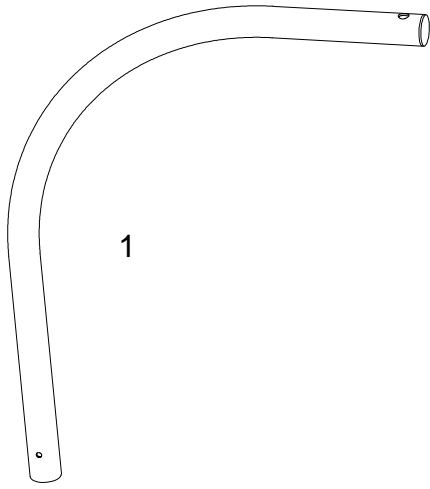



For additional product information, help assembling a product, or for any other customer support issue, please contact our customer service team.

Walker Edison Furniture, LLC
4350 West 2100 South, Salt Lake City, UT 84120
Toll Free: 1-877-203-2917
www.walkerediton.com
Monday - Friday 8 am to 5 pm (MST)

Parts List

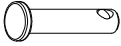

Hardware List

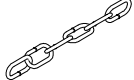
A		M10x35mm	Bolt	1	pc
B		M8x60mm	Bolt	1	pc
C		M8mm	Flat washer	2	pcs
D		M8mm	Nut	1	pc
E			Bolt cap	1	pc
F		M 5	Hex Key	1	pc
G		M 8	Hex Key	1	pc
H			Wrench	1	pc
J			Iron bolt	1	pc
K			Spring hook	1	pc
L			Iron ring buckle	1	pc
M			Iron chain	1	pc

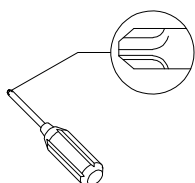

Philips head screwdriver required for assembly
(not included)

*The hardware quantities listed above are required for proper assembly.
Some extra hardware may also have been included.*

Step 1

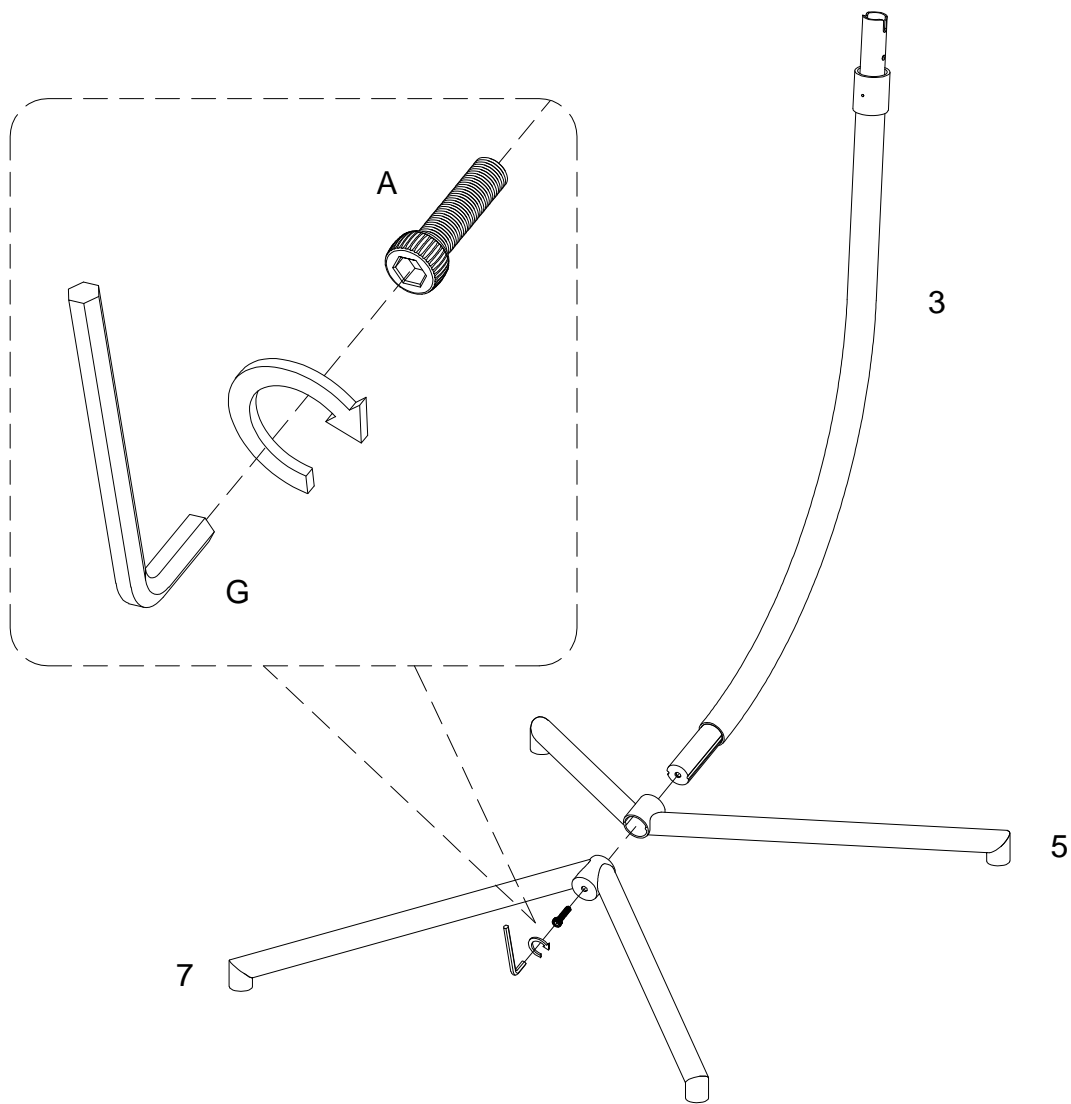

Insert part (3) into part (5) and then insert part (3) into part (7), using bolt (A) secure part (7) to part (3) to part (3) with Hex Key (G) as per diagram.

Step 2

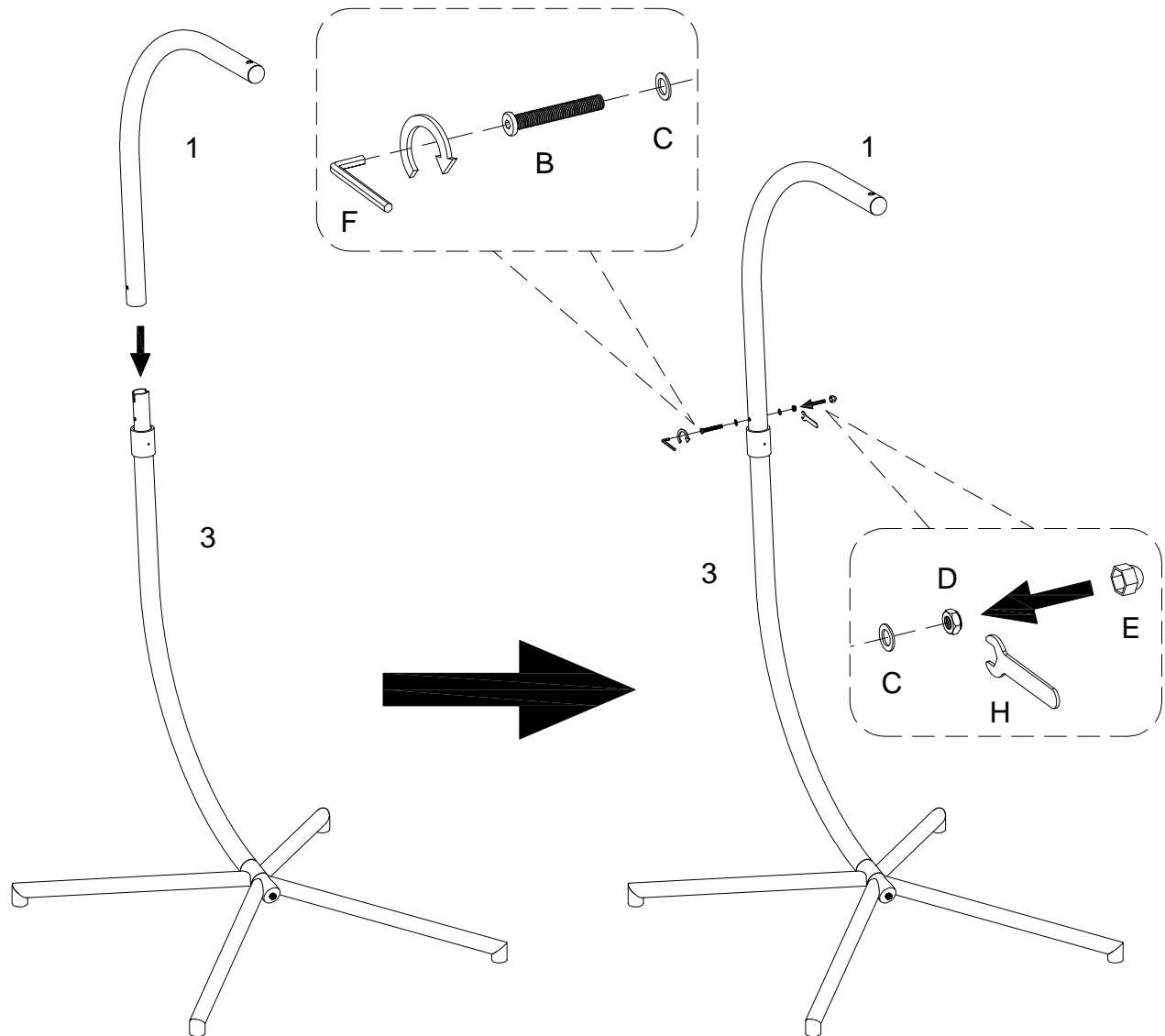

Insert part (1) into part (3) ,place the bolt (B) with Flat washer (C) across parts (1,3) ,keep Hex key (F) into the head of bolt (B) and using wrench (H),tighten Nut (D) with flat wash (C) to bolt (B) to fix part (1,3) together ,using bolt cap (E) cover the Nut (D) as per diagram.

Step 3

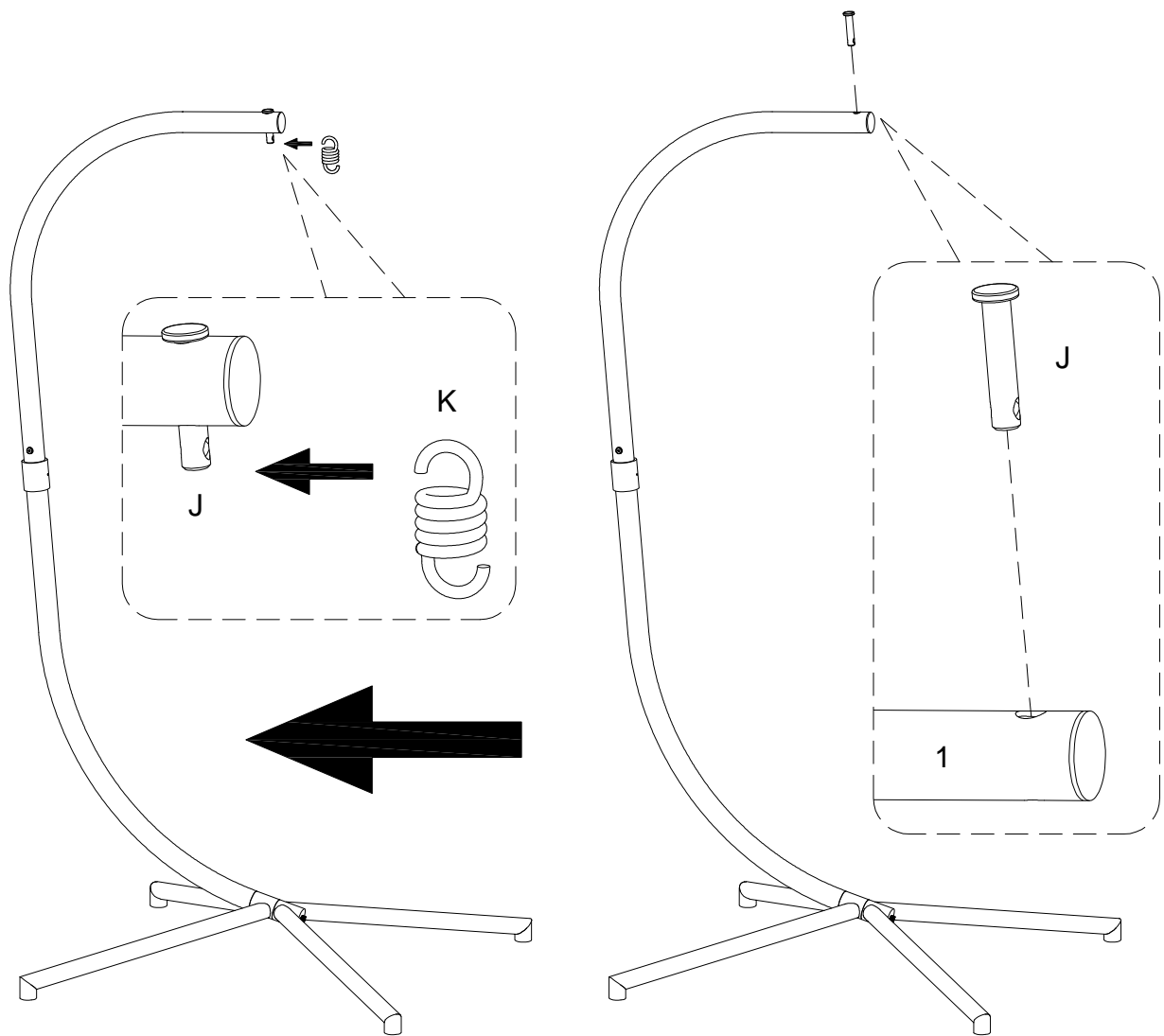

Insert Iron bolt (J) into part (1) ,then place spring hook (K) into iron bolt (J) as per diagram.

Step 4

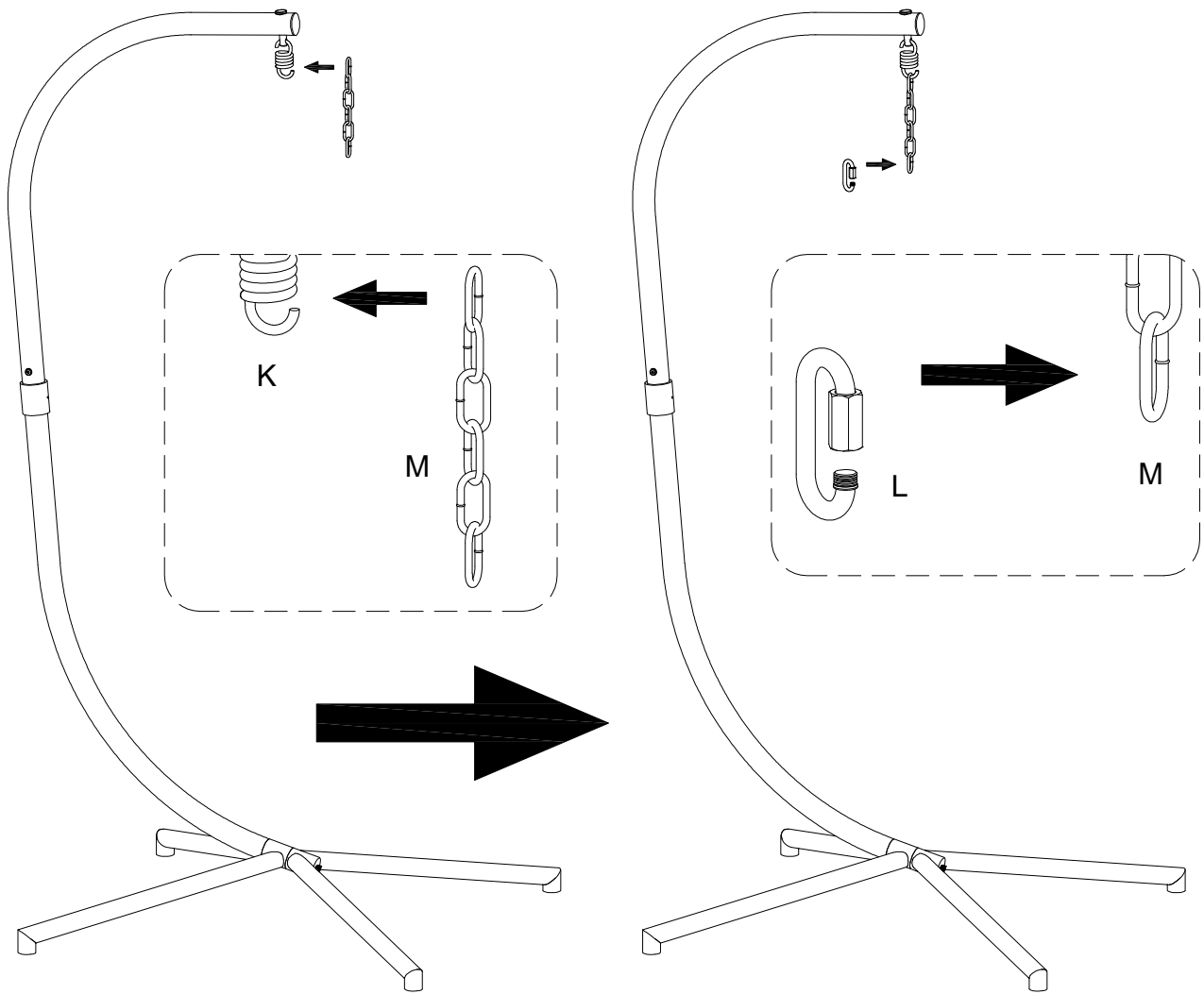

Place Iron Chain (M) to part (K) ,then connect iron ring buckle (L) to part (M) as per diagram.
Note:Please keep the iron ring buckle open.

Step 5

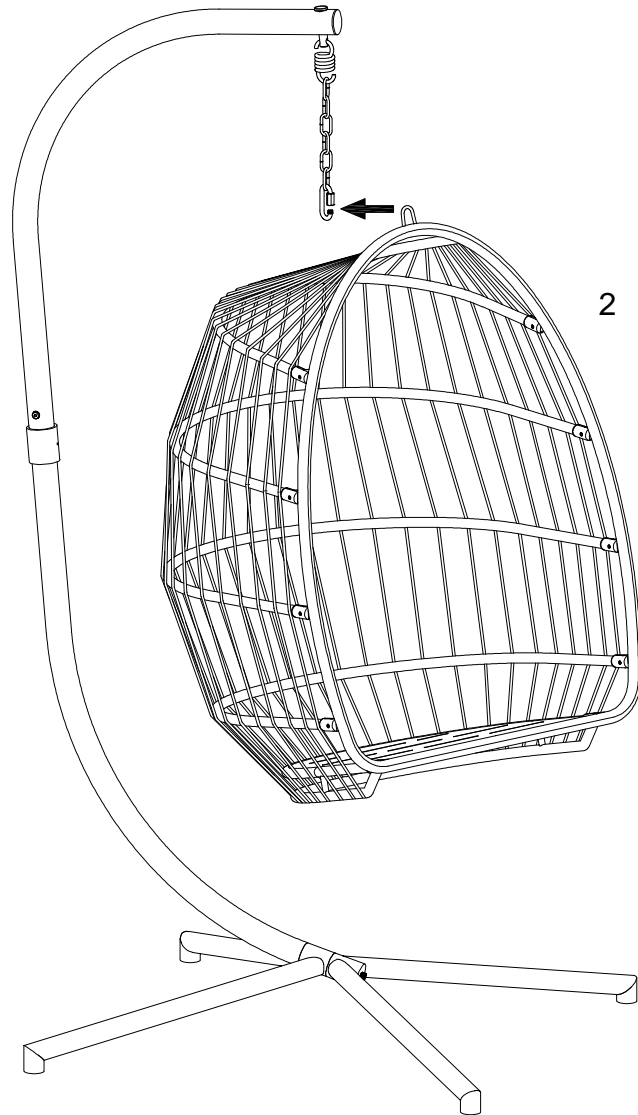
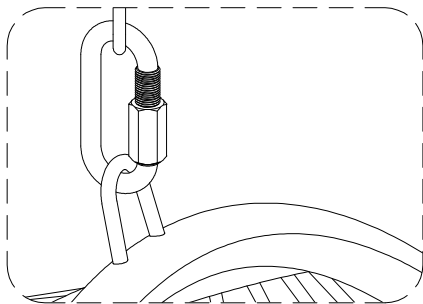
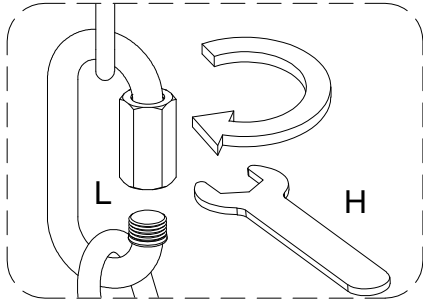
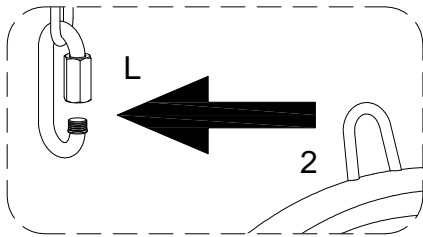

Pick up part (2) into Iron ring buckle (L) ,then secure and tighten iron ring with Wrench (H) buckle as per diagram.

Note : If you want to adjust the seat height ,you can adjust height phase of chain (M)to place the iron ring buckle to adjust the seat height . If you want to adjust the seat height. Fasten the iron ring buckle (L) lay down part (2) and choose the desired phase of iron chain (M) for placing iron ring buckle (L) and repeat this step .

Step 6

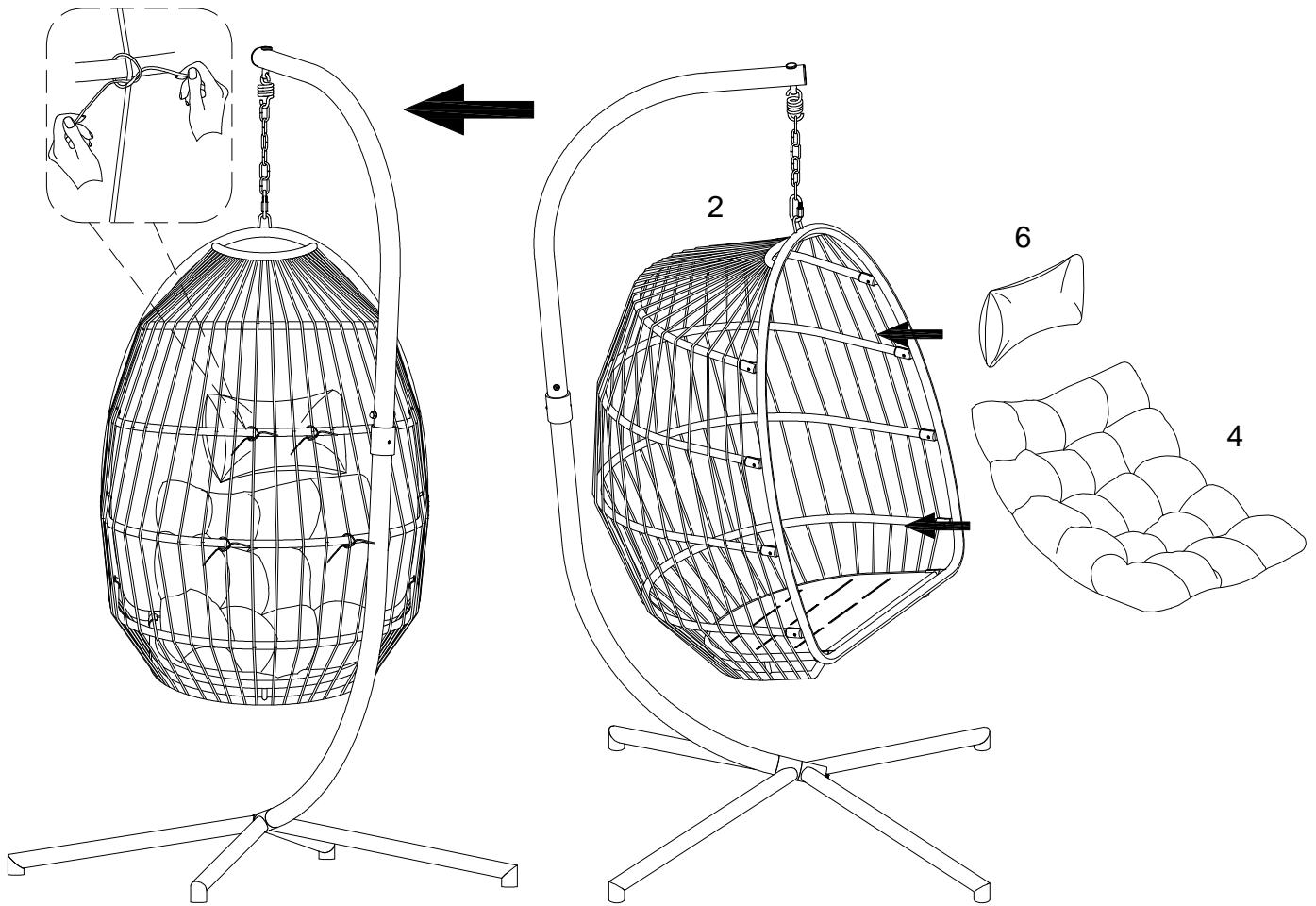

Put parts (4,6) as per diagram, then tighten all the belts to part (2).

Step 7

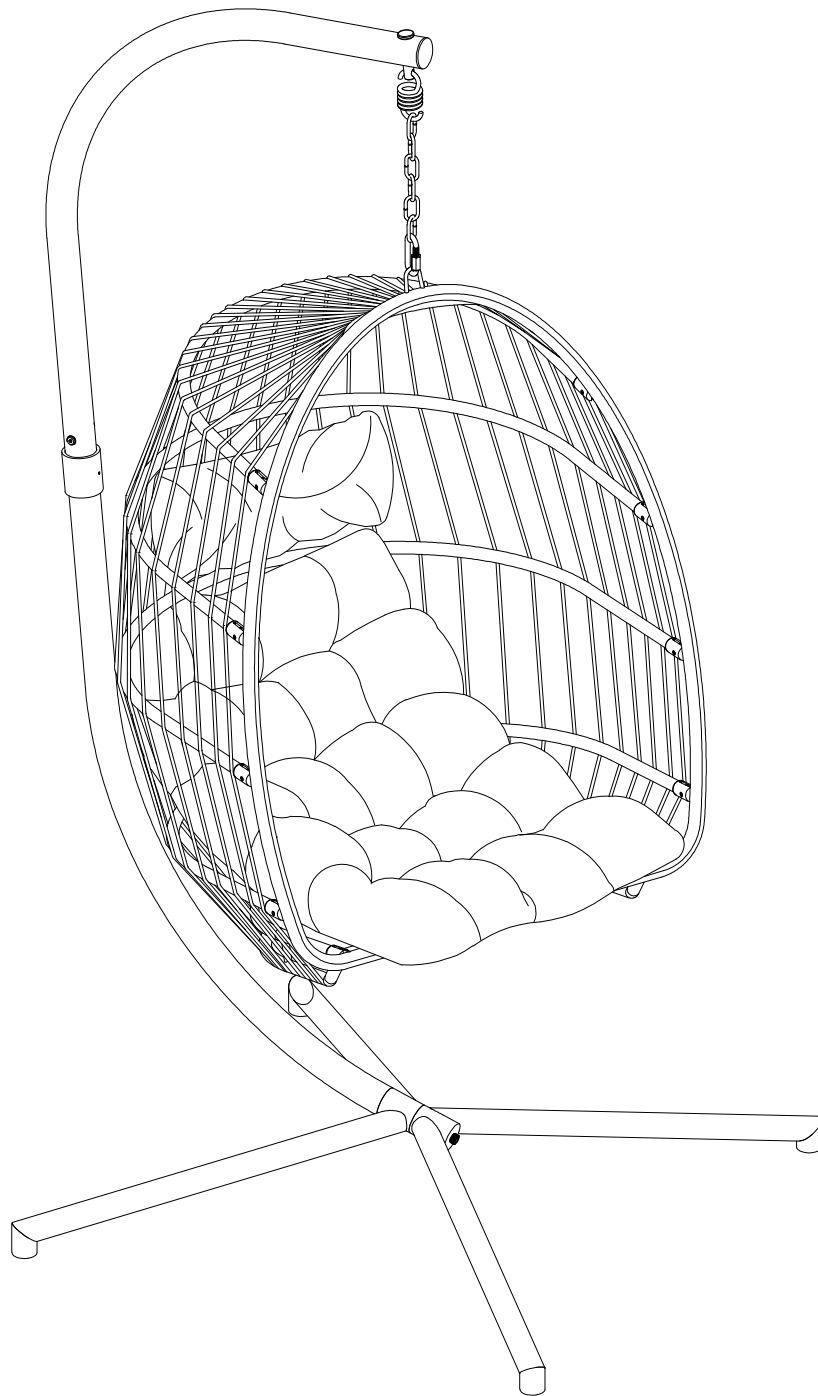

Final Assembly