



Assembly Instructions

Identify All Parts Packed In The Carton Against The Parts List. Remove All Protective Materials. Place Parts On A Non-abrasive Surface To Avoid Scratching. Do Not Attempt Assembly If Any Parts Are Missing Or Damaged.

Warning: Please Do Not Use Acid Or Alkaline Washing Liquid To Clean The Product.

Assemble The Product As Below Show Step By Step

Part List

NO.	SKETCH	DESCRIPTION	QTY	NO.	SKETCH	DESCRIPTION	QTY
A		Back Frame	1	AA		M6x20 Bolt	12
B		Seat Frame	1	BB		Washer	12
C-L		Left Arm	1	CC		Bolt Cover	12
C-R		Right Arm	1	DD		Wrench	1
D		Back Cushion	1	EE		Foot Glider	4
E		Seat Cushion	1				

STEP 1

Hand Tighten Nut 3-4 Revolutions Only, Do Not Tighten All The Bolts And Nut.

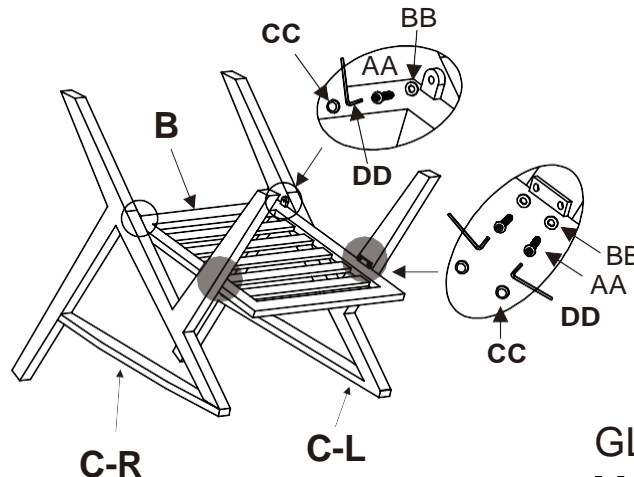

GL3A-5147-121KD
Made in China

STEP 2

Hand Tighten Nut 3-4 Revolutions Only, After Attached All The Bolts, Adjust All The Part At Correct Position, Then Tighten All The Bolt And Nut. Do Not Over Tighten.

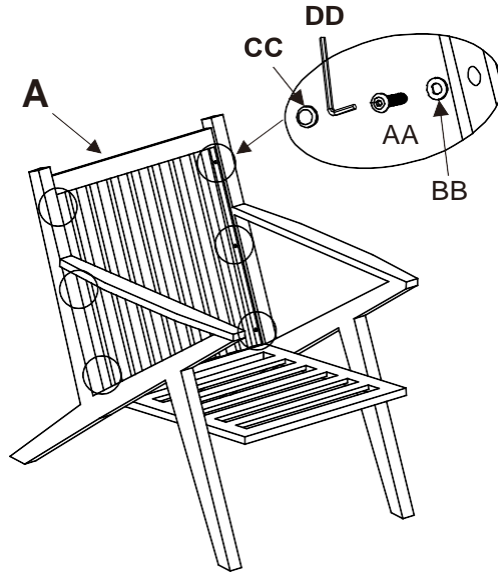

STEP 3

Need two people turn the sofa right side up. Adjust the pre-installed foot glider (EE) at the end of each sofa leg until the sofa is level with the ground. Securely, Your sofa is ready for use.

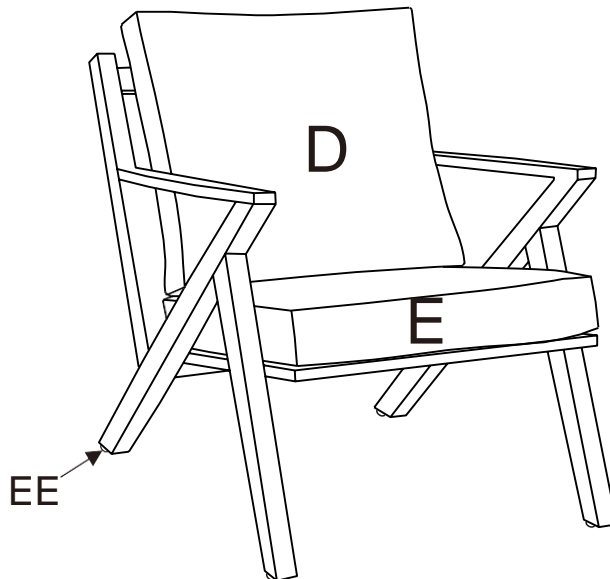

2

*DO NOT OVER TIGHTEN

*NO SOCKET DRIVERS



*NO POWER TOOLS

