

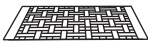





Thanks for purchasing this quality product. Be sure to check all packing materials carefully for small parts, which may have come loose inside the carton during shipment. Identify and count all parts and compare with the Hardware List below

PARTS LIST

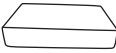
NO.:	PIC	DESC	QTY
A		Top Part	1 pc
B		Leg Part	2 pcs
C		Seat Cushion	1 pc

PARTS LIST

NO.:	PIC	DESC	QTY
D		Bolt M6x45	8 pcs
E		Spring Washer M8	8 pcs
F		Washer M6	8 pcs
G		Allen Key	1 pc

Step 1: Place the Top part (A) on the clean, soft surface as a blanket or carpet. Assemble the Legs part (B) to the Top part by Bolt, Spring Washer, Washer M6 (D, E, F) and loosely tightening with Allen key (G).

When inserting the bolts, loosely tighten each about 5-6 full turns and ensure each of the 8 bolts fit well.

Once all 8 are inserted and loosely tightened, proceed to fully tighten each bolt.

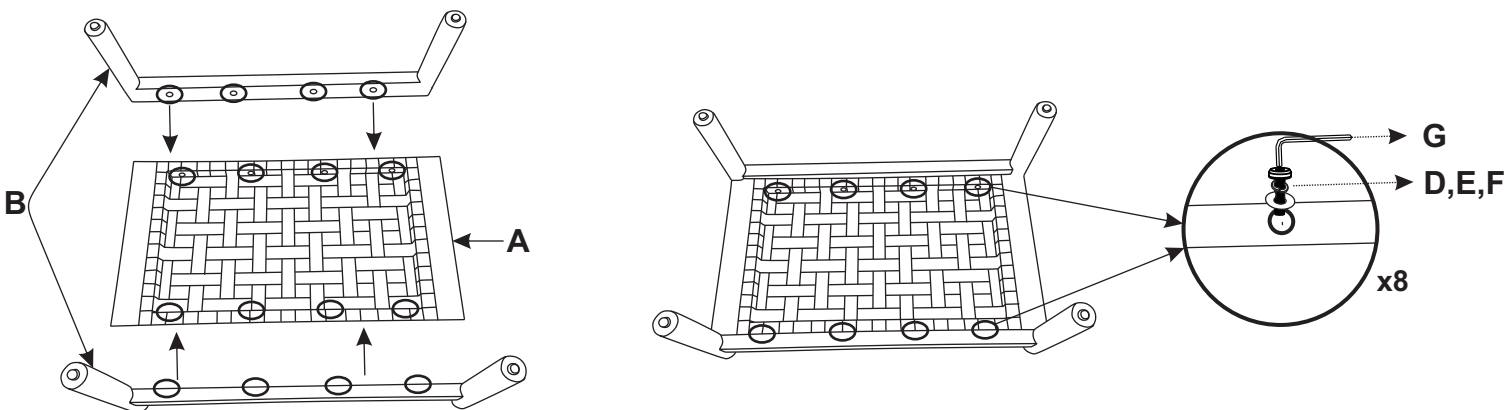

Step 2: After assembling, put the seat cushion (C) on the wooden part and your product is ready to use.

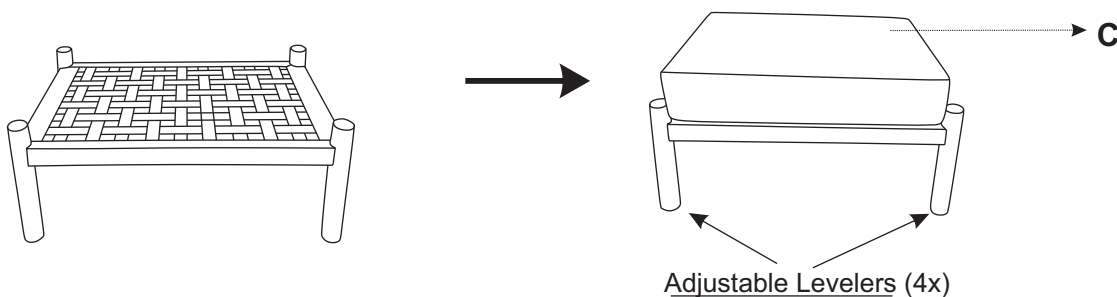

Periodically check and make sure all bolts are fully tightened.

Assembly Completed