









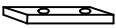

Thanks for purchasing this quality product. Be sure to check all packing materials carefully for small parts, which may have come loose inside the carton during shipment. Identify and count all parts and compare with the Hardware List below

PARTS LIST

Item	Photo	Description	Qty
A		Chair Seat	1
B		Chair Base	1
C		Bolt (5/16-18*1.77")	4
D		Aluminum Plates	4
E		Flat Washer	4

Item	Photo	Description	Qty
F		Lock Washer	4
G		Nut	4
H		Nut Cover	4
I		Wrench	2
J		Seat Cushion	1
K		Back Cushion	1

1. Place the chair seat (A) on a non-abrasive flat surface. Align the holes on the support bar on the underside of the chair seat with the holes on the spring plates attached to the T-rocker that is pre-attached to the chair base (B). Make sure the arrow labels on the rocker mechanism and chair support bar are facing the same direction—towards the front of the chair. Insert bolts (C) through the metal plates (D), support bar, spring plate and the metal plates (D) as shown in the diagram. Secure bolts with flat washers (E), lock washers (F) and nuts (G). The support bar and spring plate should be sandwiched in between the metal plates (D).

Warning: Improper assembly may result in serious personal injury.

Once all the nuts and bolts are in place, securely tighten all the bolts (C) and nuts (G), including the ones at the front part on the rocker mechanism with the wrench (I). Cover all nuts with nut covers (H). Place the seat cushions (J) and back cushions (K) on the chairs.

REPEAT ABOVE STEPS TO ASSEMBLE THE ANOTHER SWIVEL ROCKING CLUB CHAIR.

Your swivel rocking club chair is ready for enjoyment.

①

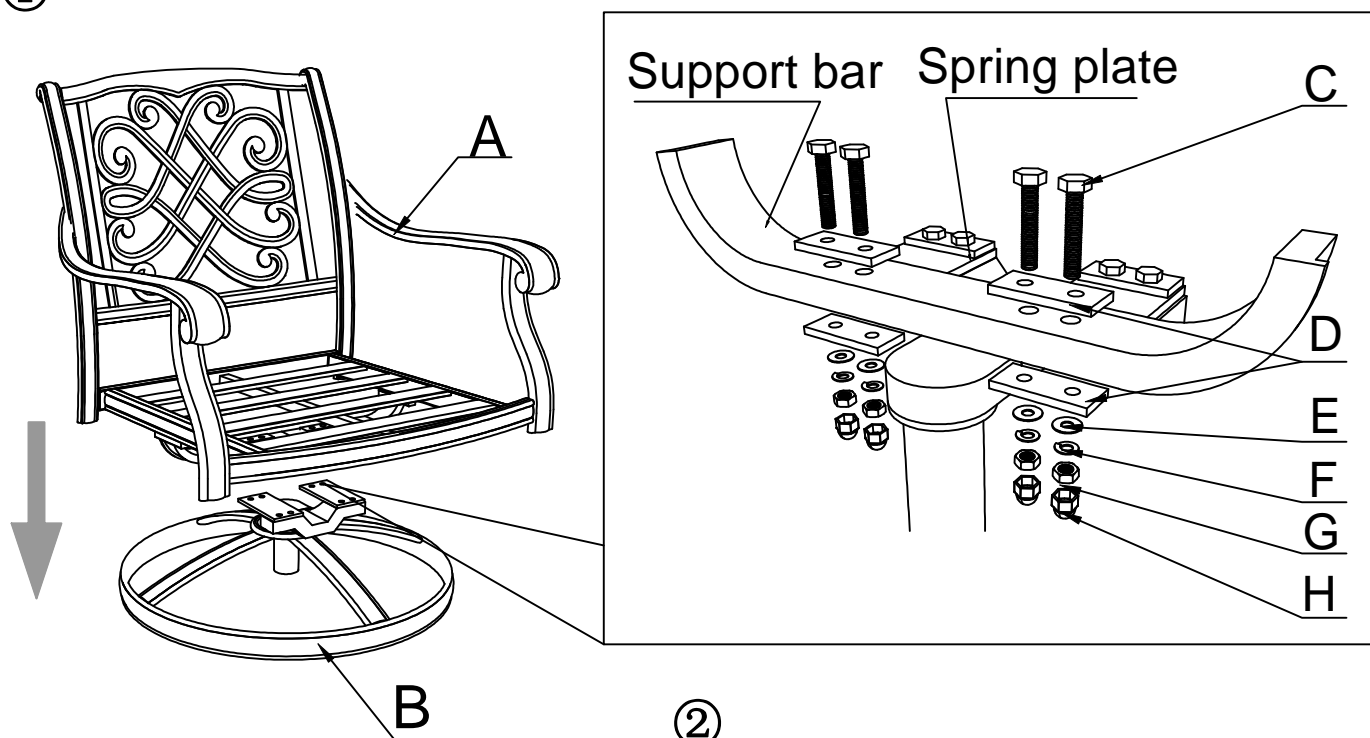

②

