

Thanks for purchasing this quality product. Be sure to check all packing materials carefully for small parts, which may have come loose inside the carton during shipment. Identify and count all parts and compare with the Hardware List below

Caution: Loosely pre-assemble all the bolts first. Do not fully turn until all bolts are inserted into the proper holes.

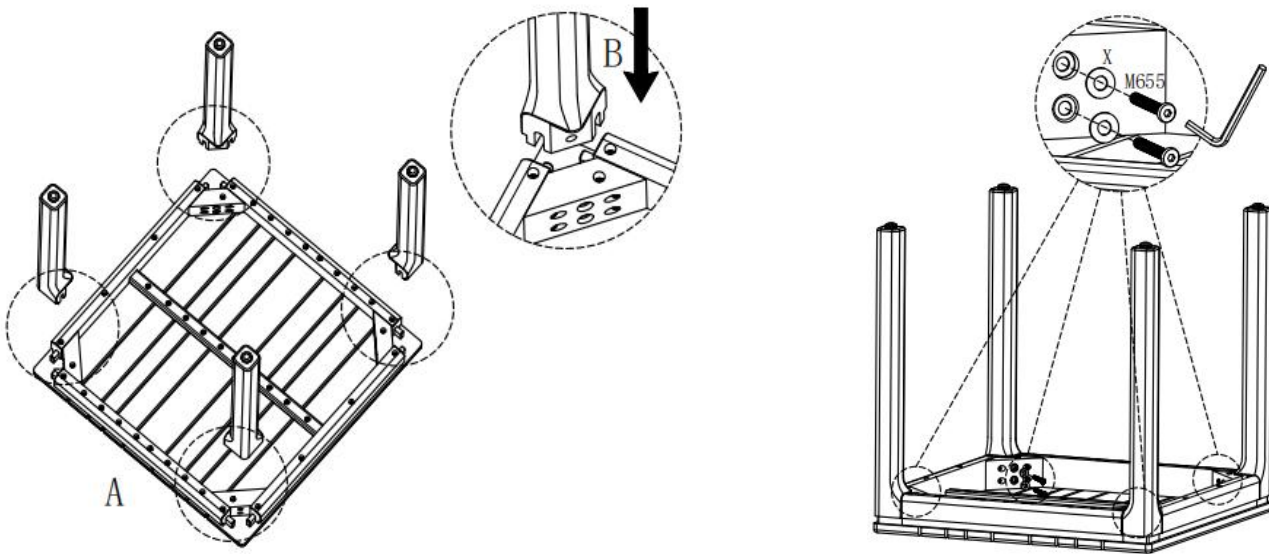



Step 1: Place the Table Top(Part A) on a clean, soft surface as a blanket or carpet. Assemble the Table Leg(Part B) to the Top by Bolt(M6*55)(Part C), tighten with Allen Key(Part Z).



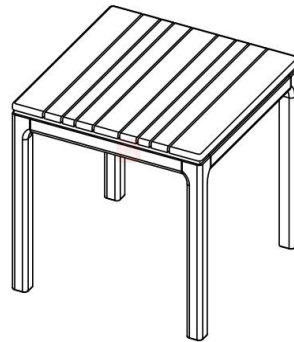

Step 2: After tightening all bolts, your product is ready for use.

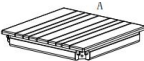

PARTS LIST

NO.:	PIC	DESC	QTY
A		Table Top	1pc
B		Table Leg	4 pcs

PARTS LIST

NO.:	PIC	DESC	QTY
C	 M6*55	Bolt(M6*55)	8 pcs
X	 Φ 12*Φ6.5*1.0	Washer(Φ12*Φ6.5*1)	8 pcs
Z		Allen Key	1pc

Periodically check and make sure all bolts are fully tightened.