







Thanks for purchasing this quality product. Be sure to check all packing materials carefully for small parts, which may have come loose inside the carton during shipment. Identify and count all parts and compare with the Hardware List below

PARTS LIST

Item	Photo	Description	Qty
A		Table Top	1
B		Table Leg	4
C		Leg Collecting Ring	1
D		Bolt (5/16-18*1.18")	4
E		Bolt (5/16-18*1.38")	4

Item	Photo	Description	Qty
F		Flat Washer	8
G		Lock Washer	8
H		Nut	4
I		Nut Cover	4
J		Bolt Cover	4
K		Wrench	1
L		Allan Wrench	1

1. Place the table top (A) upside down on a non-abrasive flat surface. Align the holes in table legs (B) with the holes in the table top (A), Loosely secure table legs (B) to the table top (A) with the short bolt (D) through flat washer (F), lock washer (G) and nut (H). Do not tighten the bolts at this point.

to table legs (B) with the long bolt (E) through flat washer (F), lock washer (G). Do not tighten the bolts at this point.

3. Check the alignment of all table legs (B), and adjust if necessary. Once the alignment is correct and all bolts are in place, Properly tighten all the bolts (D&E) and nuts (H) using wrench (K) and allen wrench (L). Cover the nuts (H) and the bolts (E) with nut covers (I) and bolt covers (J). Carefully turn the table to the upright position.

The table is ready for your enjoyment.

①

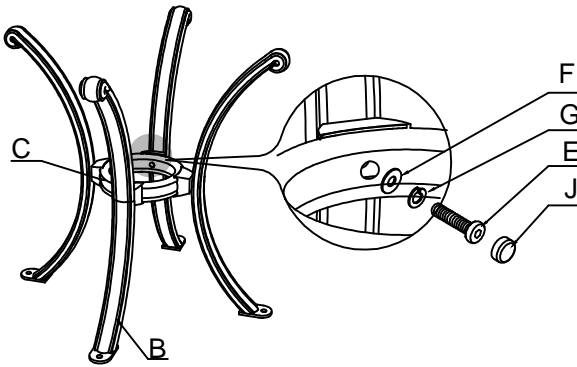

②

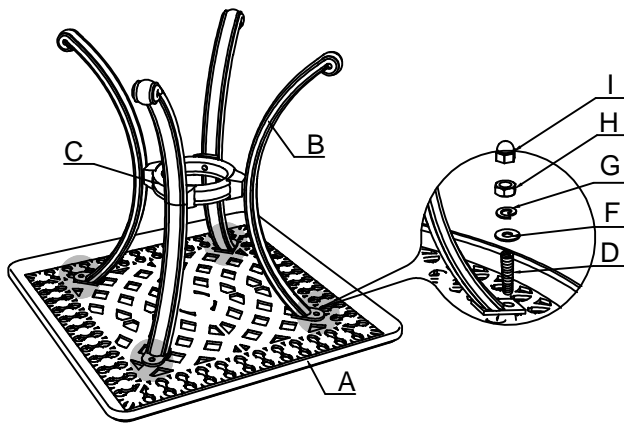

③

