

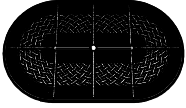







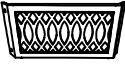
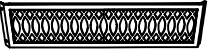

# ASSEMBLY INSTRUCTIONS

ABOL CARINA 42"X72" OVAL DINING TABLE  
SKU 74200432

Thanks for purchasing this quality product. Be sure to check all packing materials carefully for small parts, which may have come loose inside the carton during shipment. Identify and count all parts and compare with the Hardware List below

## PARTS LIST

Item	Photo	Description	Qty
A		Table Top	1
B		Table Leg	4
C		Short Leg Collecting Panel	2
D		Long Leg Collecting Panel	2
E		Umbrella Cover	1

Item	Photo	Description	Qty
F		Bolt (5/16-18*1.18")	4
G		Bolt (5/16-18*1.57")	8
H		Flat Washer	12
I		Lock Washer	12
J		Nut	12
K		Nut Cover	12
L		Wrench	1

1. Place the table top (A) upside down on a non-abrasive flat surface. Align the holes in table legs (B) with the holes in the table top (A), Loosely secure table legs (B) to the table top (A) with the bolt (F) through flat washer (H), lock washer (I) and nut (J). Do not tighten the bolts at this point.

2. Align the holes in table legs (B) with the holes in the leg collecting panels (C&D), Loosely secure the leg collecting panels (C&D) to table legs (B) with the bolt (G) through flat washer (H), lock washer (I) and nut (J). Do not tighten the bolts at this point.

3. Check the alignment of all table legs (B), and adjust if necessary. Once the alignment is correct and all bolts are in place, Properly tighten all the bolts (F&G) and nuts (J) using wrench (L). Cover the nuts (J) with nut covers (K). With the help of another person, carefully turn the table to the upright position.

Place umbrella cover (E) on table top (A).The table is ready for your enjoyment.

①

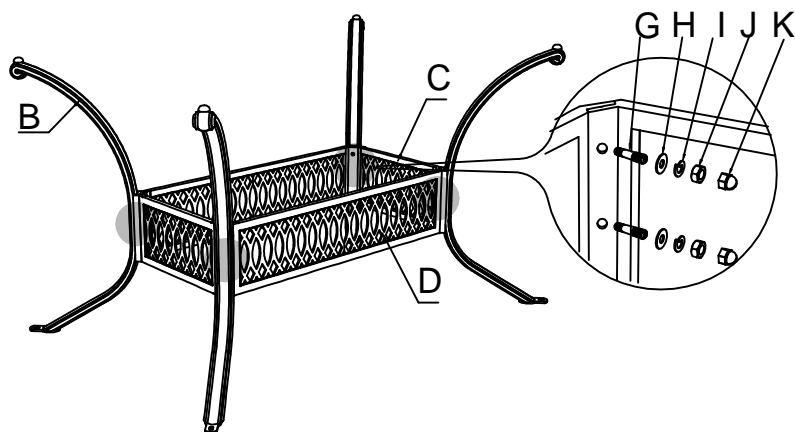

②

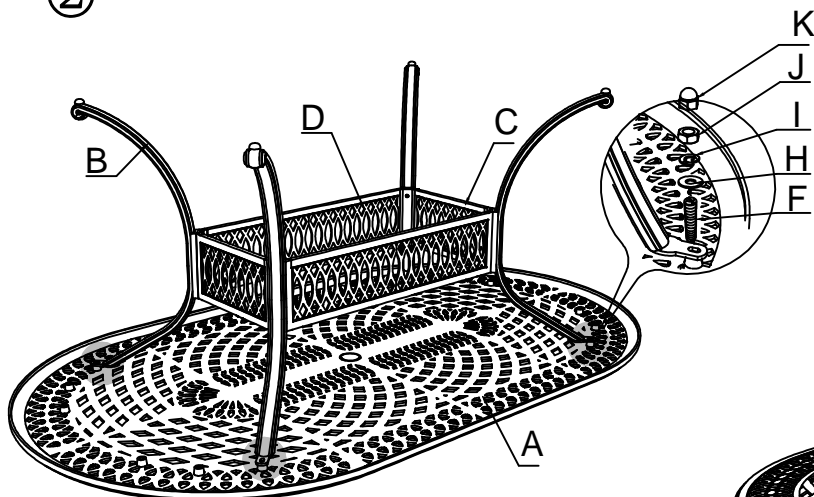

③

