









Assembly Instructions

MTTU 1015 76" Dining Table

Manufactured for Rooms To Go

SKU: 74310156

No.	PARTS LIST		QTY
P1	TABLE TOP		1
P2	LEGS		2
P3	CROSS BAR		1

No.	HARDWARE PACK		QTY
1		BOLT 1/4" - 25 x 2-3/8"	2Pcs
		SPRING WASHER 1/4"x7/16"x1.5mm(T)	2Pcs
		FLAT WASHER 1/4"x9/16"x1mm(T)	2Pcs
2		BOLT 1/4"- 25 x 1-3/8"	12Pcs
		SPRING WASHER 1/4"x7/16"x1.5mm(T)	12Pcs
		FLAT WASHER 1/4"x9/16"x1mm(T)	12Pcs
		ALLEN KEY 5/32"x2-3/4"x1-31/32"mm	1Pc
3		PARASOL CAP	1Pc
4		WOOD PLUG	2Pc

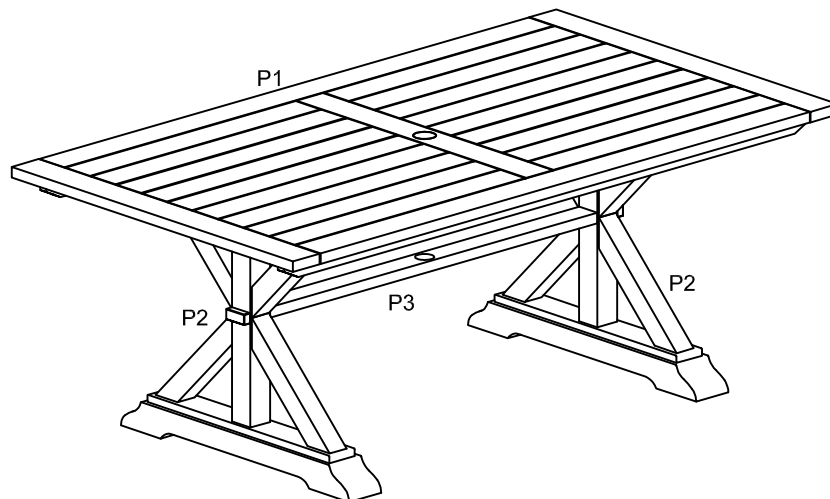

Hardware Pack Location(s): Bottom of the table that the bases are attached to.

76" Dining Table, 74310156

Assembly Instructions

MTTU 1015 76" Dining Table

Manufactured for Rooms To Go

SKU: 74310156

***Caution: Please read all instructions carefully before starting the assembly process. These parts are cumbersome and heavy. Therefore, two person assembly is recommended in order to prevent personal injury and damaged parts .

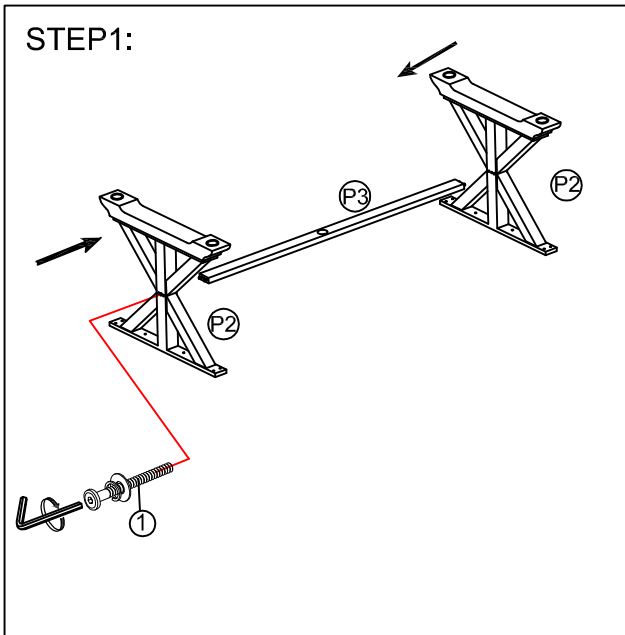

Assemble the cross bar (P3) into the leg.
Note: Do not fully tighten the bolts until the last step.

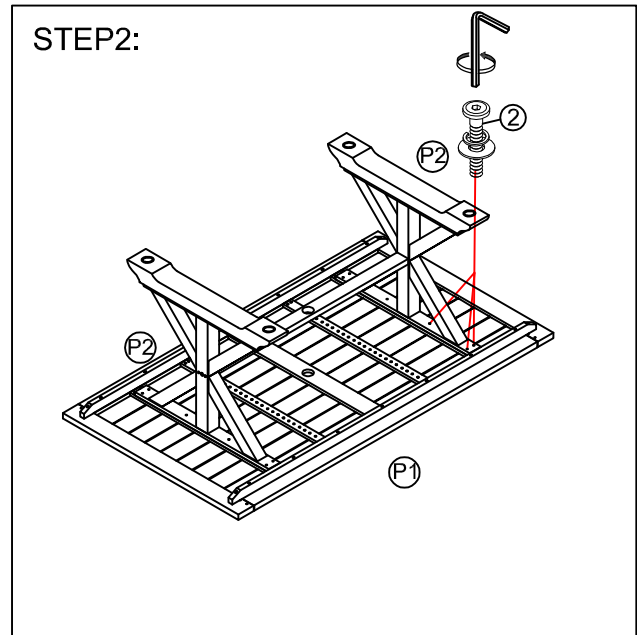

Put the bottom of table up, assemble the leg into table top. Tighten the bolts.

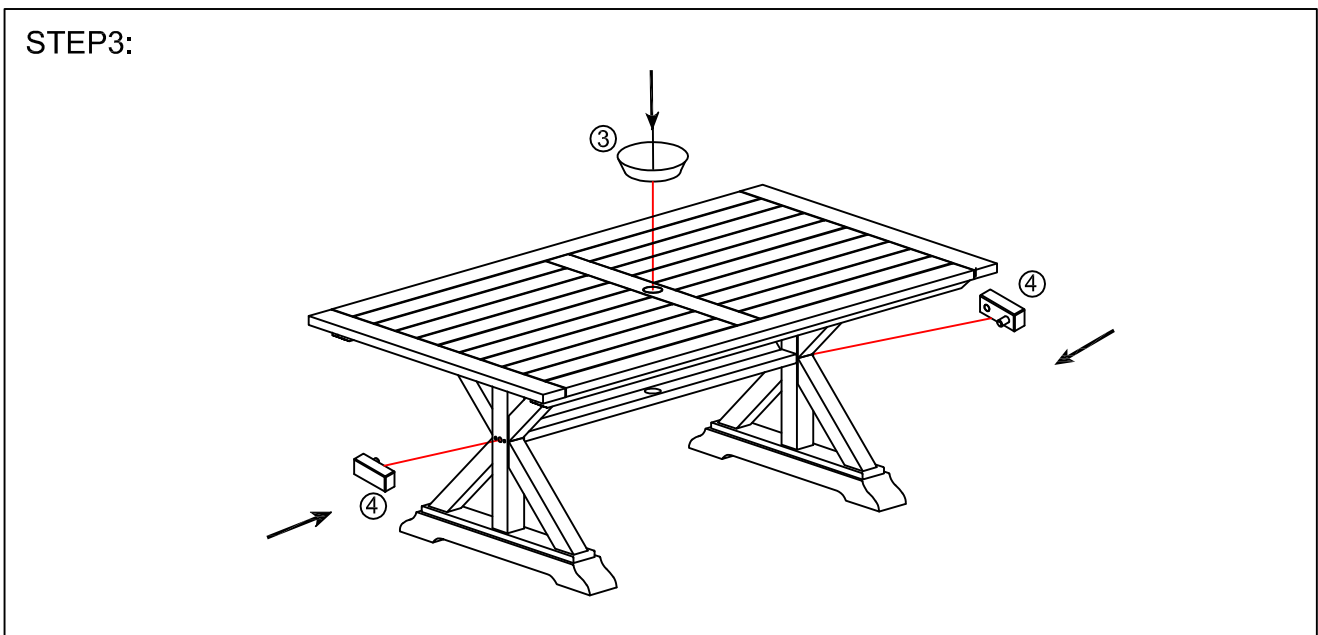

Turn the table over, put parasol cap (3) into the table top. After that put the wood plug (4) into the leg and finish.