

Manufactured for Room to Go

ASSEMBLY INSTRUCTIONS

EXGM SOUTHPORT DINING SIDE CHAIR
SKU#74400424

EXGM RIALTO DINING SIDE CHAIR
SKU#74400385/74400397

SUN VALLEY DINING SIDE CHAIR
SKU#74417013

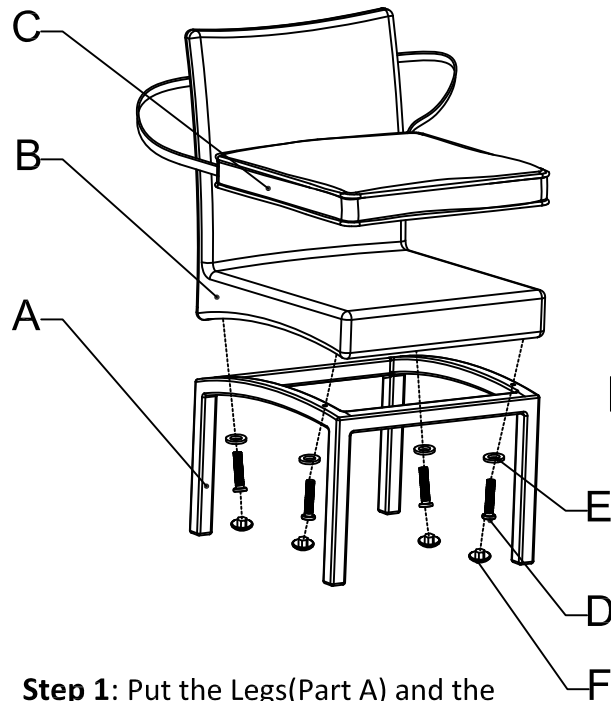

Step 1: Put the Legs(Part A) and the Seat(Part B) together. Assemble the Seat(Part B) to the Legs(Part A) by Screw(Part D) and loosely tightening with the Allen Key.After all screws have been assembled,fully tighten each one.

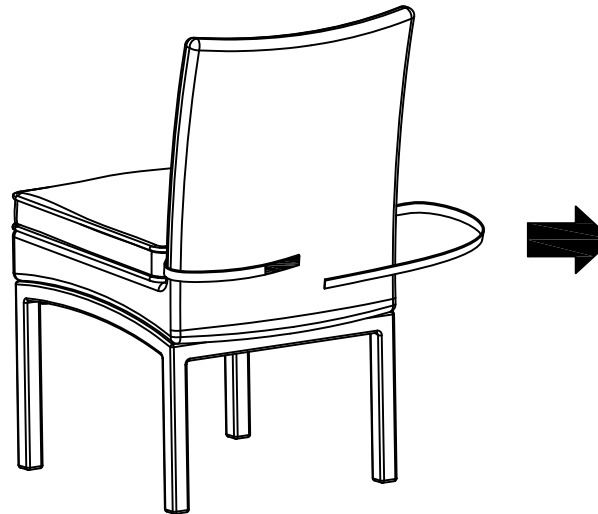



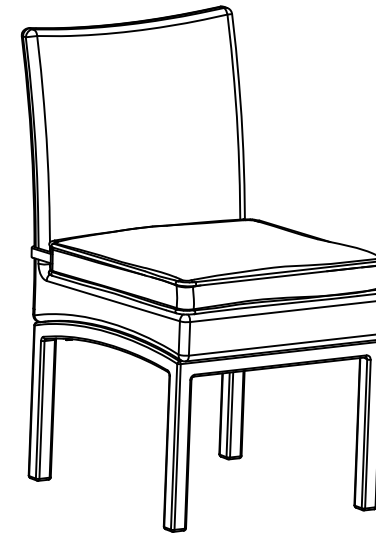



Step 2: Put the Seat Cushion(Part C) on the Seat. Tie the Hook and Loop Tape.



Step 3: Put the screw covers (F) on to cover the screw heads for a better look. Now your product is ready for use.

PARTS LIST

NO.	A	B	C	D	E	F	G
DESC	Legs	Seat	Seat Cushion	Screw 1/4-20x55	Washer	Screw cover	Allen Key
PIC							
QTY	1pc	1pc	1pc	4pcs	4pcs	4pcs	1pc