

ASSEMBLY INSTRUCTIONS

EXGM SOUTHPORT DINING ARM CHAIR
SKU#74500426

EXGM RIALTO DINING ARM CHAIR
SKU#74500387/74500399





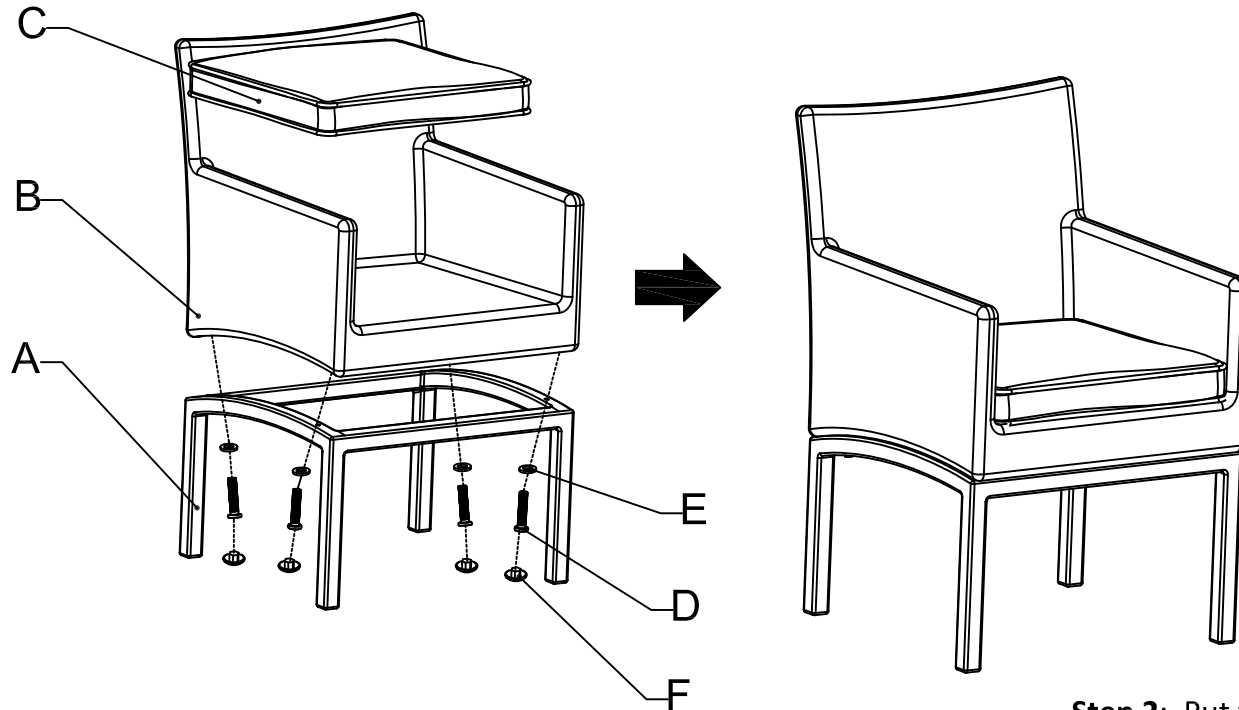

SUN VALLEY DINING ARM CHAIR
SKU#74517015

Step 1: Put the Legs (Part A) and the Seat (Part B) together. Assemble the Seat (Part B) to the Legs (Part A) by Screw (Part D) and loosely tightening with the Allen-Key. After all screws have been assembled, fully tighten each one. Then put the Seat Cushion (Part C) on the Seat (Part B).



Step 2: Put the screw covers (F) on to cover the screw heads for a better look. Now your product is ready for use.

PARTS LIST

NO.	A	B	C	D	E	F	G
DESC	Legs	Seat	Seat Cushion	Screw 1/4-20x55	Washer	Screw cover	Allen Key
PIC							
QTY	1pc	1pc	1pc	4pcs	4pcs	4pcs	1pc