

# ACME FURNITURE

Acme Furniture Industry, Inc.

## PATIO FURNITURE & ACCESSORIES ASSEMBLY INSTRUCTIONS

### **STOP - IMPORTANT**

If you have any problems with this product(missing or damaged parts, assembly issues), please

**CONTACT YOUR LOCAL FURNITURE DEALER**







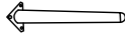

# ASSEMBLY INSTRUCTION FOR ACME FURNITURE

MODEL# OT01095-1/OT01095-2 7Pc Patio Dining Set

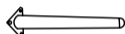
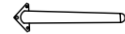
Thank you for purchasing this quality product. Be sure to check all packing material carefully for small parts which may have come loose inside the carton during shipment. Separate, identify and count all parts and metal hardware. Compare with parts list to be sure all parts are present. If any part(s) are missing or damaged, please contact your local furniture dealer. For efficient and speedy service, please indicate the model number and code letter of part(s) needed.

\*\*\*Do not fully tighten screws until fully assembled\*\*\*

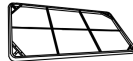
## COMPONENT PARTS

DESCRIPTION	PART NAME		Q'TY(PCS)
<b>A</b>	Left back leg for chair		<b>6</b>
<b>B</b>	Right back leg for chair		<b>6</b>
<b>C</b>	Left front leg for chair		<b>6</b>
<b>D</b>	Right front leg for chair		<b>6</b>
<b>E</b>	Seat for chair		<b>6</b>
<b>F</b>	Back cushion for chair		<b>6</b>
<b>G</b>	Seat cushion for chair		<b>6</b>
<b>H</b>	Legs for table		<b>4</b>
<b>I</b>	Table		<b>1</b>
<b>J</b>	Glass for table		<b>1</b>

# HARDWARES REQUIRED

①  Bolt M6\*20MM- 8 4 pcs

②  Washer - 8 4 pcs

③  Key allen - 1pc

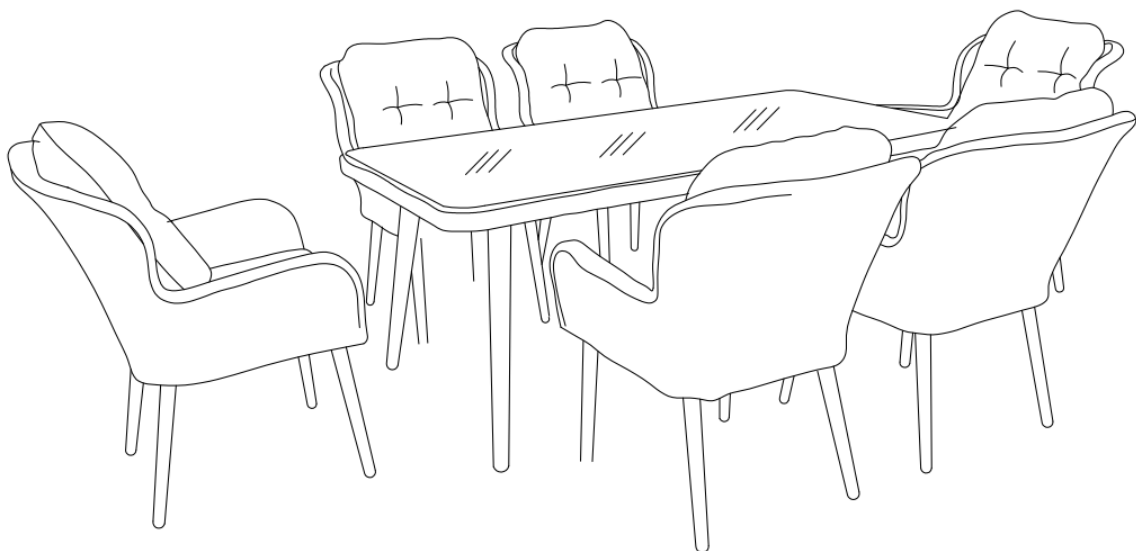

## Attention

\*\*\* Some number parts listed on the instruction sheet may not be in parts bag as they may already be assembled.

Carefully check parts and packing material prior to ordering replacements.

How to assemble:

STEP1

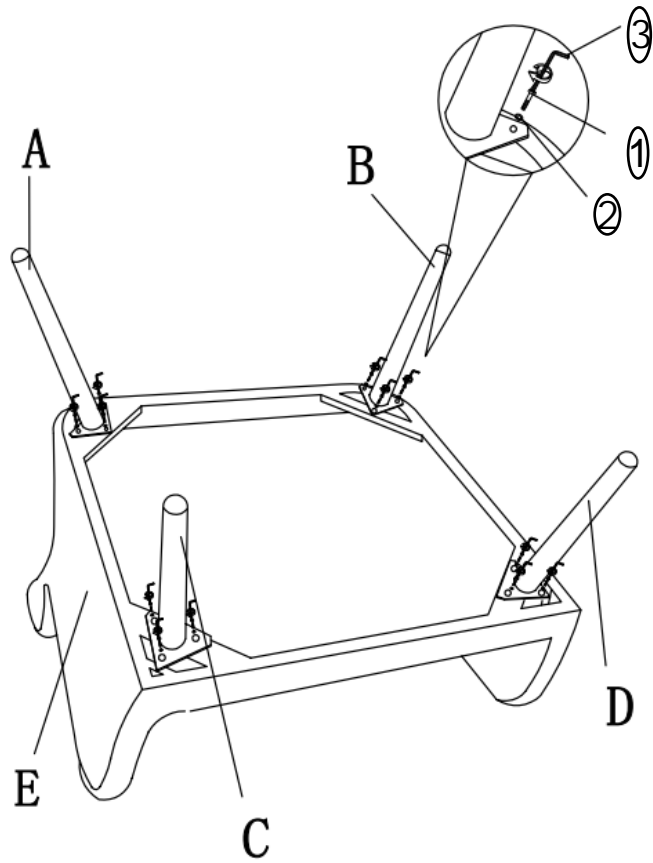

STEP2

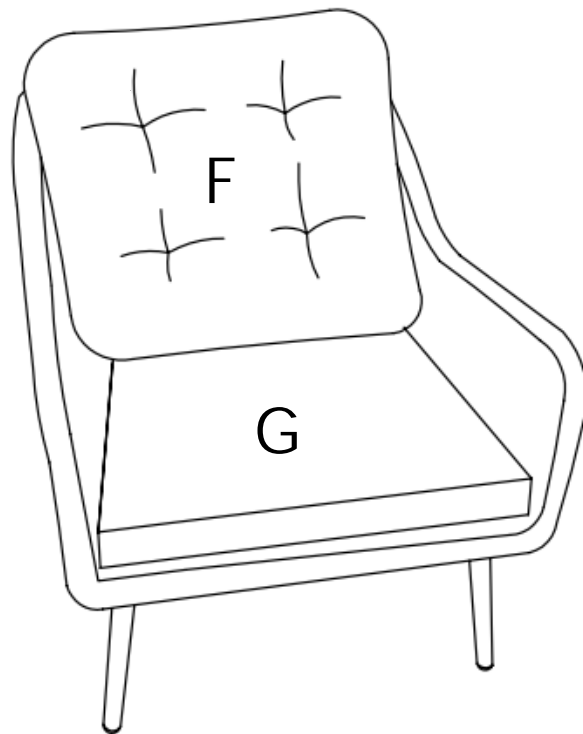

STEP3

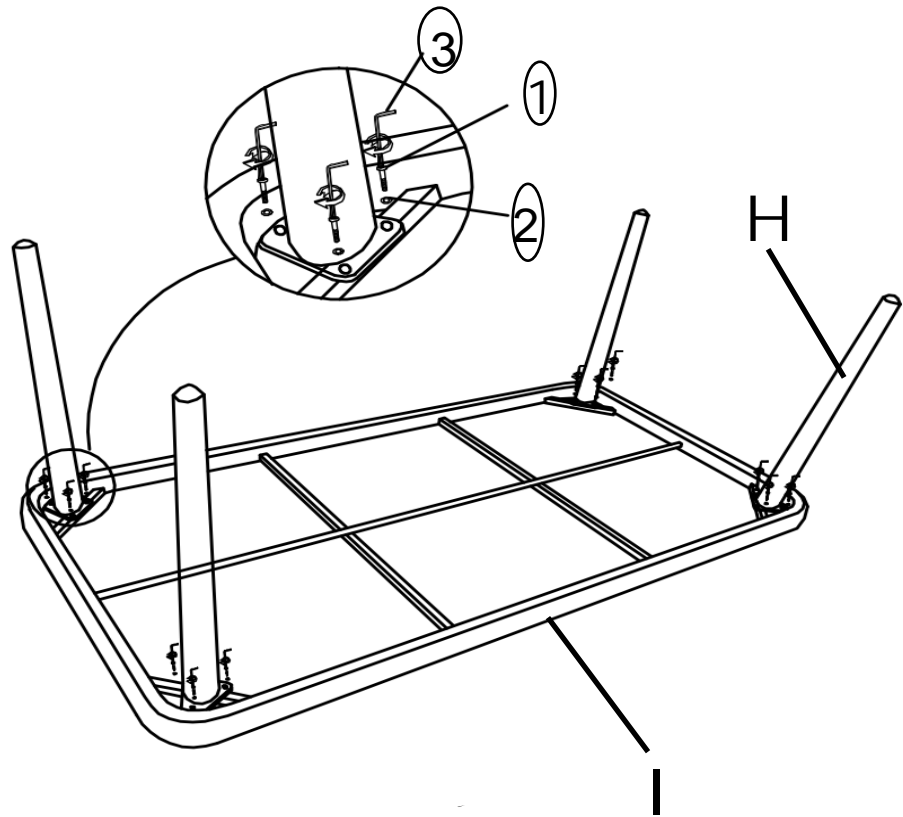

STEP4

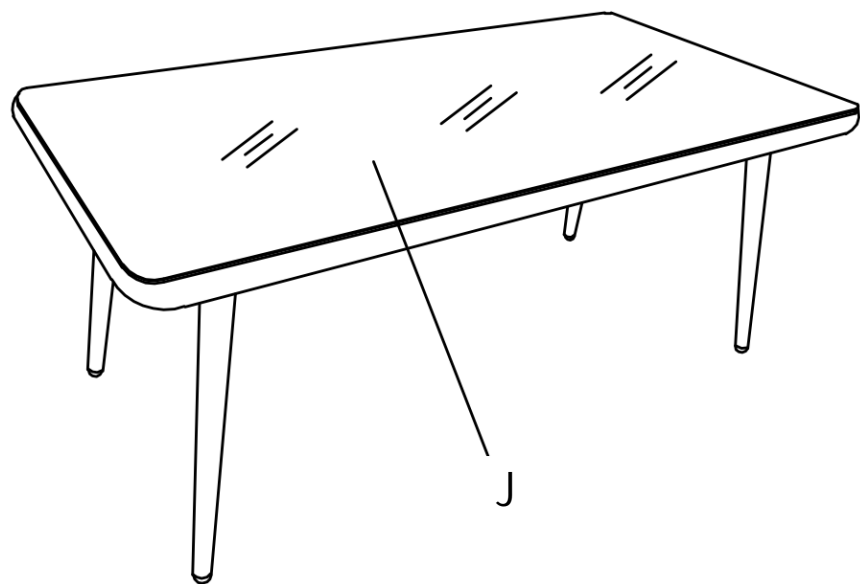

# Safety and Care Advice

To clean your furniture we advise using warm soapy water. Use a mild cleaner to avoid damaging the finish. Apply the cleaner using a soft hand brush which will help loosen any stubborn dirt

Once cleaned, the soapy water can be rinsed off with clean water, and the suite will need to be allowed to dry thoroughly prior to storing. Do not store the suite away whilst wet

To clean the glass, use an appropriate cleaner, and apply with a soft cloth

We recommend the furniture is stored away when not in use to prolong the life of your product

It is recommended to use a heat mat when placing hot or cold dishes on the glass surface

Care should be taken when sitting down on the furniture with any sharp objects (garden tools and knives) in your pockets, as these could tear any fabric or pierce through the resin weave, causing irreparable damage.