





Assembly Instructions

MTTU 1014 76" Dining Bench

Manufactured for Rooms To Go

SKU: 74910146

No.	PARTS LIST		QTY
P1	SEAT FRAME		1
P2	LEGS		2
P3	CROSS BAR		1
P4	SUPPORT BAR		1
P5	SHORT SUPPORT BAR		2

No.	HARDWARE PACK		QTY
1		SCREW 1/4"-11x4"	5Pcs
2		BOLT 1/4"-25x1-3/8"	8Pcs
		SPRING WASHER 1/4"x11x1.5mmT	8Pcs
		FLAT WASHER 1/4"x14x1mmT	8Pcs
3		ALLEN KEY 4x70x50mm	1Pc
		SCREW 1/6"-7x1"	8Pcs
4		SCREWDRIVER	Not provided
		WOOD PLUG	2Pcs
		RUBBER HAMMER	Not provided

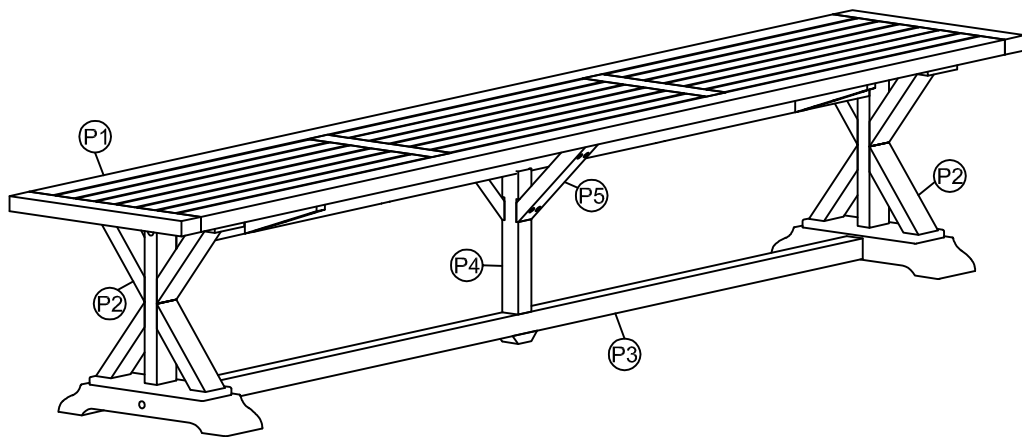

Hardware Pack Location(s): Bottom of the bench that the bases are attached to.

76" Dining Bench, 74910146

Assembly Instructions

MTTU 1014 76" Dining Bench

Manufactured for Rooms To Go

SKU: 74910146

***Caution: Please read all instructions carefully before starting the assembly process. These parts are cumbersome and heavy. Therefore, two person assembly is recommended in order to prevent personal injury and damaged parts .

STEP1:

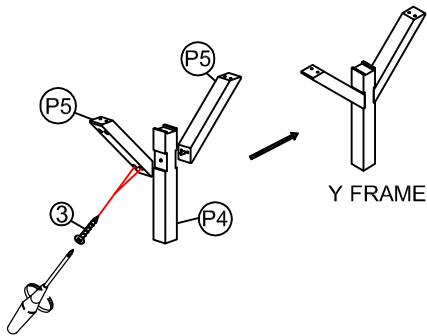

Assemble the short support bar (P5) into the support bar (P4).

STEP2:

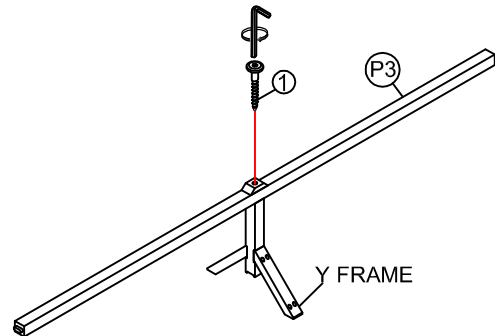

Assemble the Y frame into the cross bar (P3).

STEP3:

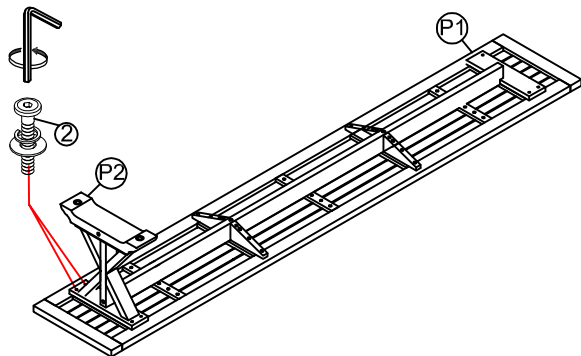

Put the seat frame bottom of Bench up, assemble the leg into Bench frame.

Note: Do not fully tighten the bolts until the last step.

STEP4:

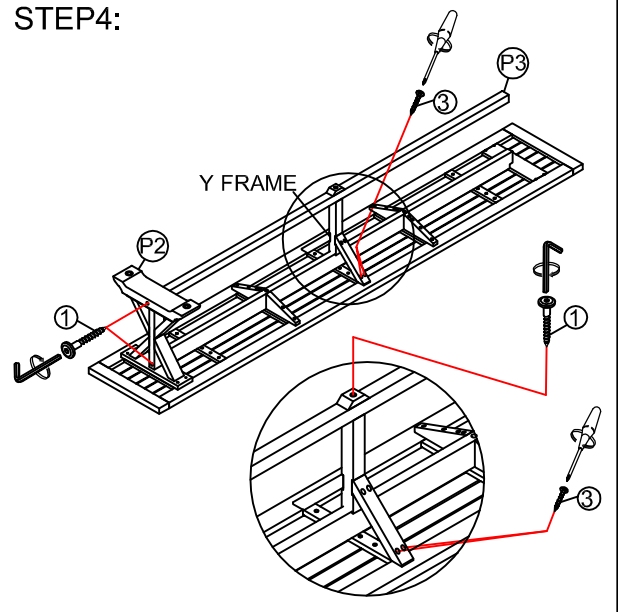

Assemble the Y frame and cross bar (P3) into the leg.

Note: Do not fully tighten the bolts until the last step.

Assembly Instructions

MTTU 1014 76" Dining Bench

Manufactured for Rooms To Go

SKU: 74910146

***Caution: Please read all instructions carefully before starting the assembly process. These parts are cumbersome and heavy. Therefore, two person assembly is recommended in order to prevent personal injury and damaged parts .

STEP5:

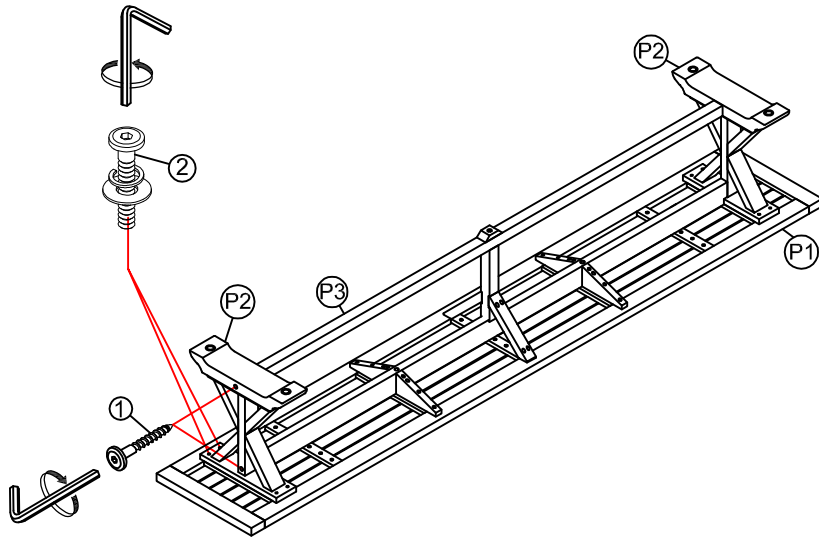

Assemble the second leg into the Bench frame. And tighten all bolts.

STEP6:

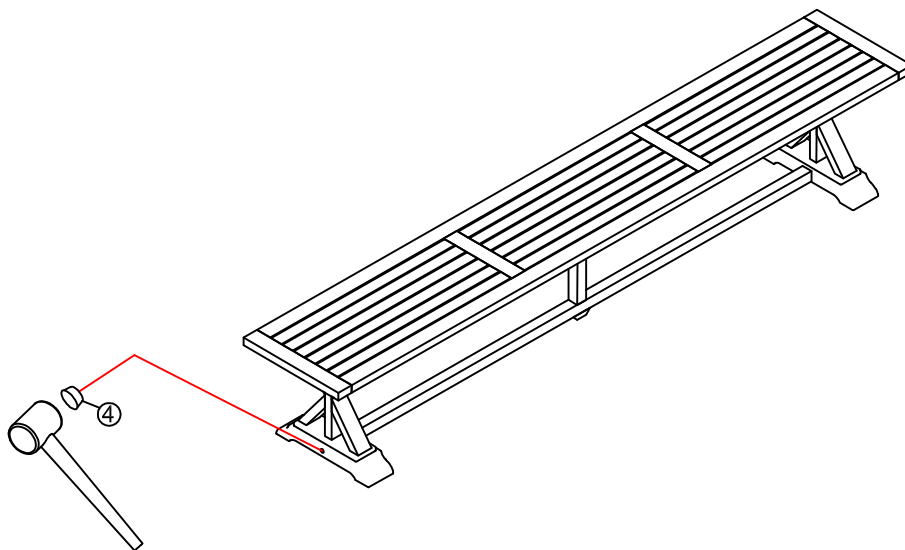

Turn the bench over and use hammer to insert the wood plug into the leg.