

Components

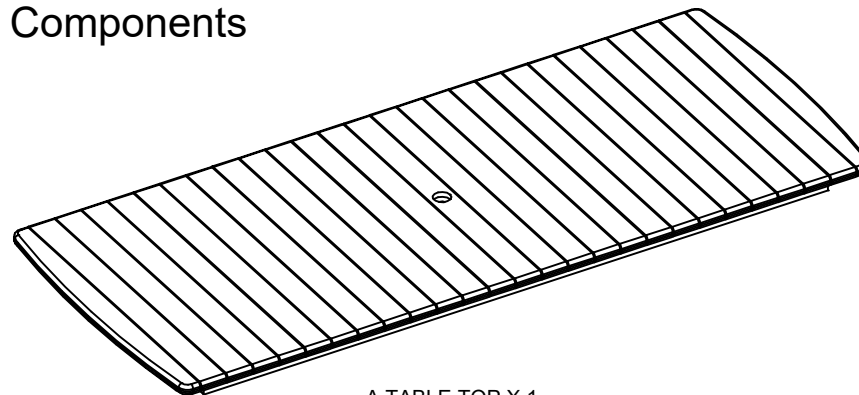

A. TABLE TOP X 1



B. LEGS X 4

These instructions must be used to ease the assembly of your furniture. Please ensure that you have all the components before assembly. Remember to place the part on a carpeted floor or blanket in order to protect them from damage while you assemble.

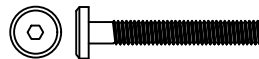

① Bolt M8 x 70 = 8 pcs



② (Ø8.5 x 13 ) x 2 = 8 pcs



③ Ø(8.5 x 20) x 2 = 8 pcs

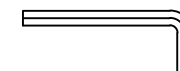

④ Allen key 4 = 1 pce

Step 1

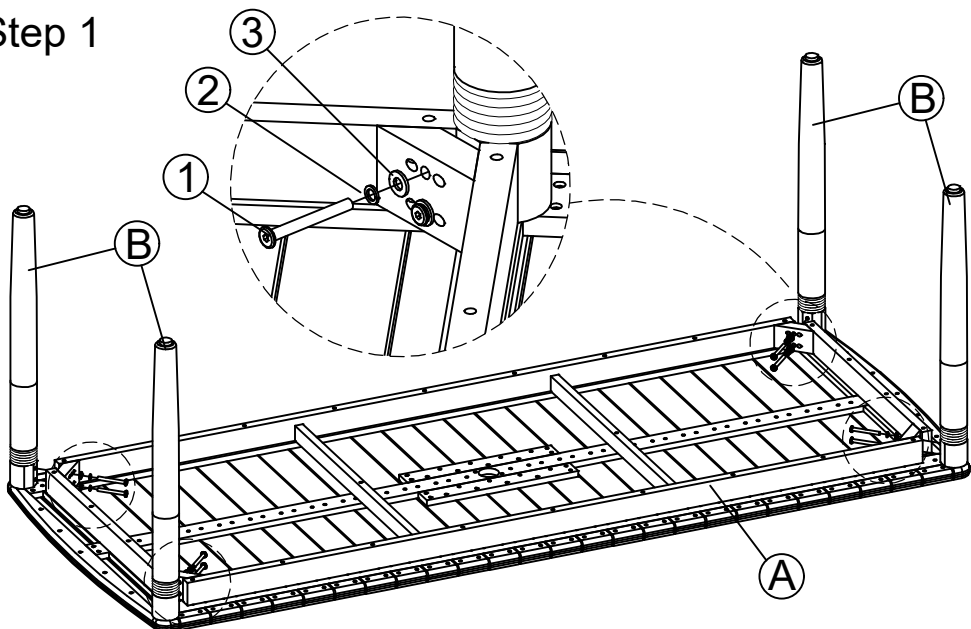

Step 2

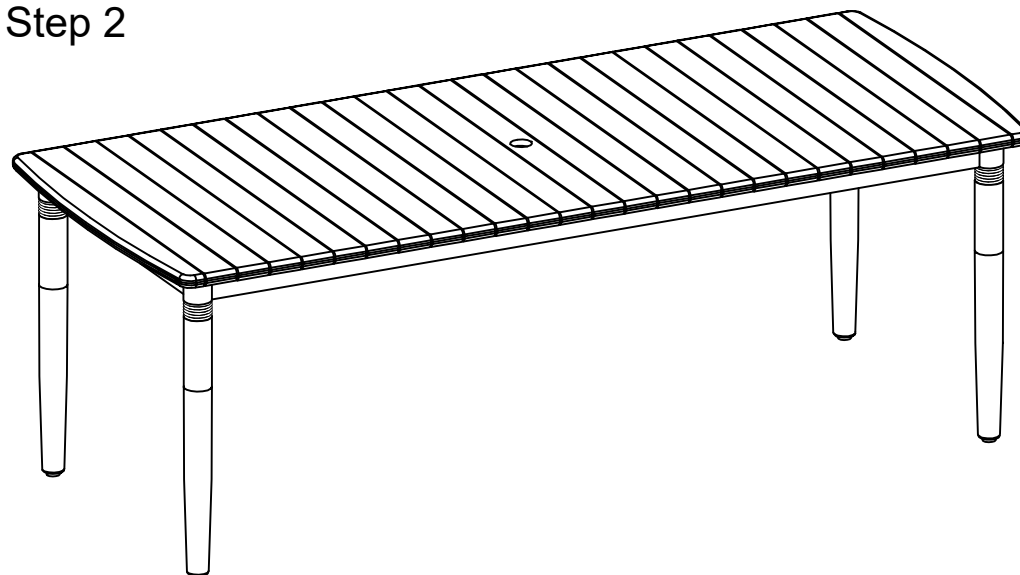

Finished

"Please DO NOT fully tighten all screw and bolts until the entire item is completely assembled"