











NO.	PART LIST		QTY
P1	LEG		1 Pc
P2	SEAT		1 Pc
P3	SEAT CUSHION		1 Pc

NO.	HARDWARE PACK		QTY
1	FLAT WASHER 5/16"x5/8"x1mm(T)		8 Pcs
2	SPRING WASHER 5/16"x1/2"x2mm(T)		4 Pcs
3	BOLT 5/16" - 39 x 1-9/16"		4 Pcs
4	PLASTIC BOLT CAP		4 Pcs
5	PLASTIC NUTS CAP		4 Pcs
6	NUTS 5/16"		4 Pcs
7	SPANNER 1/2" x 3-1/2" x 2mm(T)		2 Pcs
8	STEEL SHEET		2 Pcs

**\*\*Caution:** Please read all instructions carefully before starting the assembly process. These parts are cumbersome and heavy. Therefore, two person assembly is recommended in order to prevent personal injury and damaged parts.

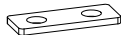
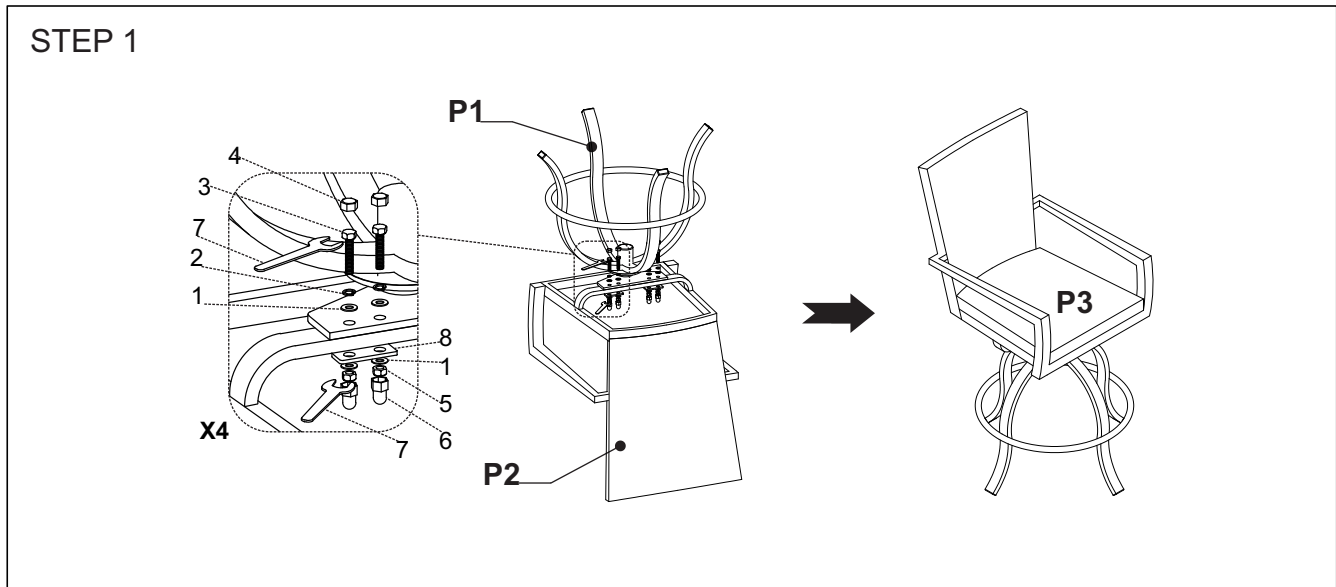

Assembled Complete

**Hardware Pack Location(s):** Bottom of the chair that the bases are attached to.